

SPECIFICATION



90t



47m



65.5m

SRC900T

SANY ROUGH TERRAIN CRANE

QUALITY CHANGES THE WORLD

crane.sanyglobal.com

It is one of the core business units in SANY Group, specializing in the development and manufacturing of high-end wheel cranes, crawler cranes and tower cranes, including the complete range of wheel cranes from 8 to 2400t, crawler cranes from 25 to 4500t and tower cranes from 6 to 185t.

三一集团旗下核心事业部，从事高端轮式起重机、履带起重机、塔式起重机系列产品的研发制造。覆盖8-2400吨全吨位轮式起重机，25-4500吨全吨位履带起重机，6-185吨塔式起重机。



SANY CRANE



SRC900T

SANY ROUGH TERRAIN CRANE
90T LIFTING CAPACITY

A 90t rough terrain crane with 5 section 47m boom, featuring stronger capacity yet reduced self-weight. Operator comfort is improved by brand new cab design.

一款最大起重量90吨，5节臂，全伸臂长47m的越野起重机，自重轻，性能强，配备全新操纵室，驾驶、操作舒适度全面升级。





Strong Lifting Capacity

超强性能

All New Operator's Cab

Ergonomic concept of safety and comfort

全新操纵室

操作安全、舒适、人机工程全面升级

Quality Components

DF Cummins engine/Dana transmission/Meritor axles

高质量关键件

东风康明斯发动机/德纳变速箱/美驰车桥

Convenient Transport

One-trailer transport at low operational cost

超便捷运输

一车整运，运营成本低

All New Operator's Cab

全新操纵室

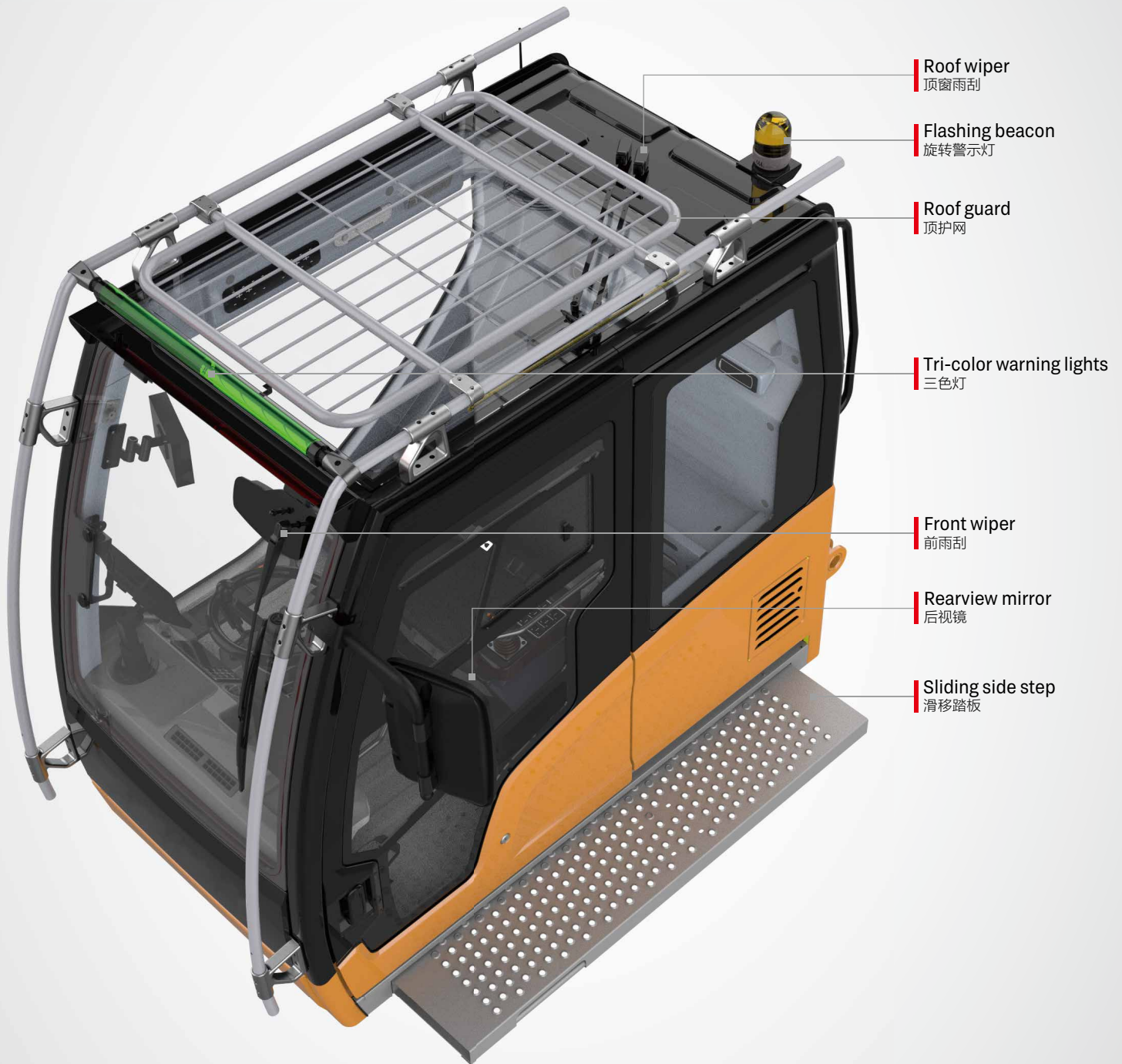

Roof wiper
顶窗雨刮

Flashing beacon
旋转警示灯

Roof guard
顶护网

Tri-color warning lights
三色灯

Front wiper
前雨刮

Rearview mirror
后视镜

Sliding side step
滑移踏板



Safety & Reliability
安全可靠



Comfort & Convenience
舒适便捷



Simplicity & Efficiency
简单高效

SPECIFICATION

Rearview and
winch monitor
卷扬监视器

10.1 inch LMI screen
10.1 吋显示屏

Outrigger control
panel
支腿控制面板

Steering column
方向柱

Pedals
踏板布置

Upper control panel
辅助面板

Emergency stop
switch
急停开关

Bubble level
水平仪

Cup holder
水杯托

Joystick
手柄

Joystick
手柄

Left control panel
左扶手箱控制面板

Right control panel &
LMI navigation knob
右扶手箱控制面板

Armrest
扶手箱

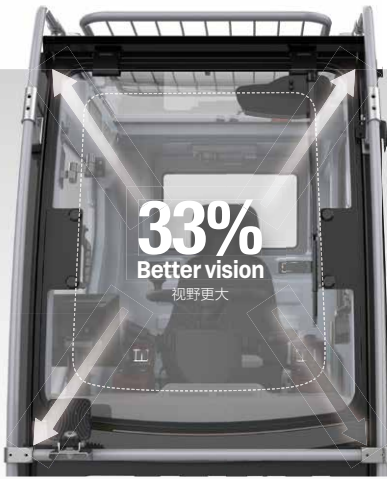

Integrating SUV genes, overall space is enlarged by 10% and forward field of vision is increased by 33%. The front windshield can be opened by 70 degrees, providing better ventilation and a second emergency exit.

融入 SUV 基因, 整体空间增大 10%, 配备超大可开合 70° 前挡风玻璃, 视野提升 33%, 增加空气对流, 并可作为快速逃生通道。



Sliding door transits between tracks when closing to make perfect thermal and acoustical insulation.

侧向变轨, 滑移门完美隔绝外部环境。

Getting in and out is made more convenient with the power sliding side step.

全宽电动伸缩踏板, 超大安全便利进出通道。

SPECIFICATION

Adjustable steering wheel for driving and controlling, modular control panels, and smart user interface deliver intuitive and highly efficient control.

驾控一体的方向盘、模块化控制面板、UI 智能操作界面，操作简单，为高效吊装保驾护航。



Convenient Transport

行驶运输便捷性

Four steering modes

四种转向模型

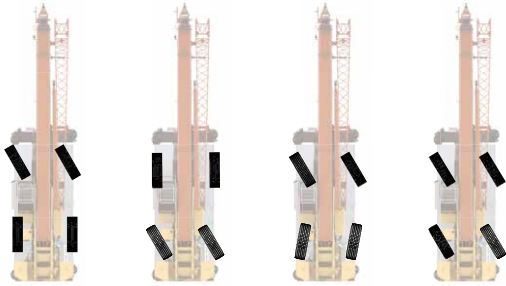

- 2 wheel front 前轮转向模式
- 2 wheel rear 后轮转向模式
- 4 wheel 四轮转向模式
- Crab 蟹行模式



Steering control panel
转向控制面板

One-Trailer Transport

一车整运

The basic machine is transported at 54t with counterweight, jib and hooks, 3.34m wide and 3.83m high, satisfying road regulations.

主机运输尺寸为宽 3.34m, 高 3.83m, 重量为 54t (带配重、副臂和吊钩), 满足道路运输要求。

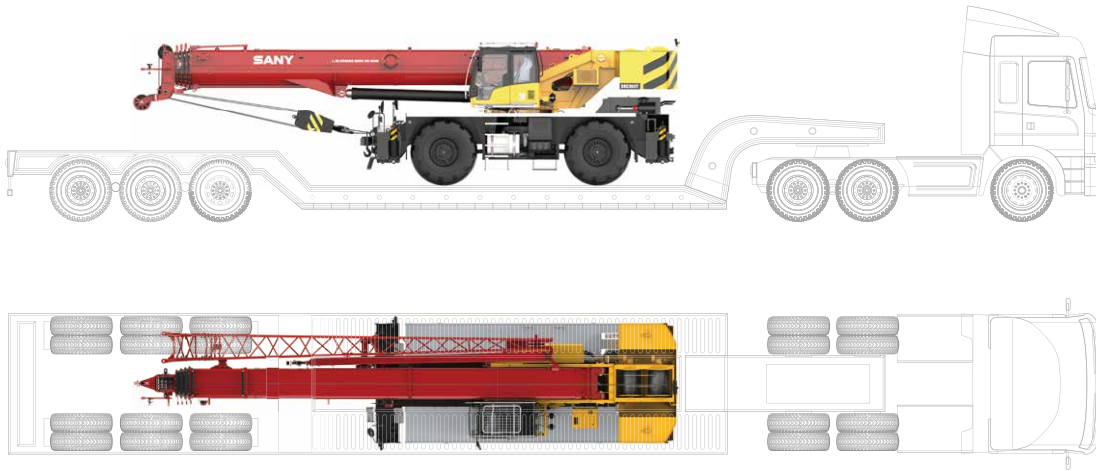

Axle Load Distribution

轴荷分布

Items 项目		Weight (kg) 重量	Load on front axle (kg) 前轴轴荷	Load on rear axle (kg) 后轴轴荷
Basic machine 主机		54000	27200	26800
Counterweight 配重		9500	-3100	12600
Fixed jib 副臂		1100	1800	-700
Aux. boom nose 臂尖滑轮		50	150	-100
Main hook 主钩	70t	690	1960	-1270
Main hook (optional) 主钩 (选配)	90t	830	2350	-1520
Auxiliary hook 副钩	8t	160	240	-80

Note: boom angle remains 0°
起重臂角度 0°

Carrier Frame

车架底盘



Inverted trapezoidal variable cross section frame is 5% less in weight and 10% stronger in rigidity.

倒梯形变截面车架，实现车架减重 5% 的同时，刚性提升 10%。

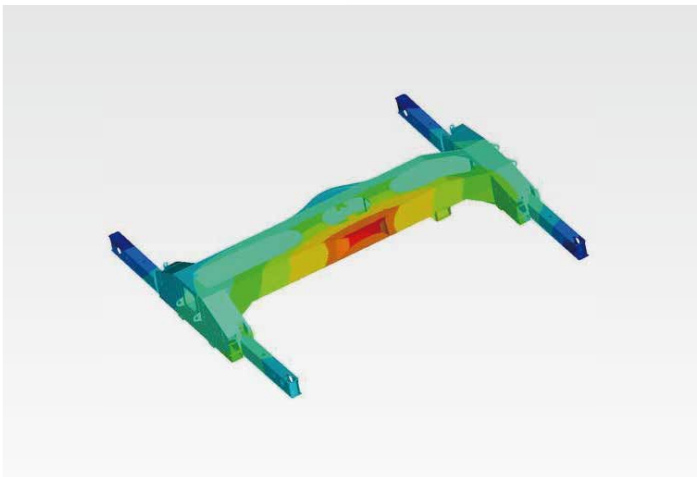

↓ 5%
Weight 重量

↑ 10%
Rigidity 刚性

Power Train

动力系统

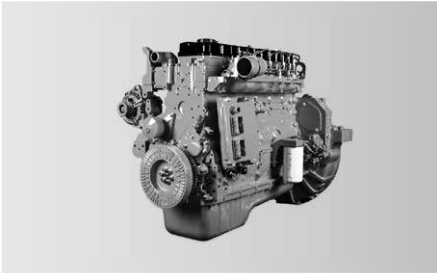

Engine

Power comes from a DF Cummins QSB6.7 inline six-cylinder water-cooled, turbocharged and intercooled off-highway diesel engine, complying with Stage III emission standard.
 Rated power: 194kW/2400rpm.
 Max. torque: 990N·m/1500rpm.

发动机

东风康明斯 QSB6.7 三阶段非道路直列六缸水冷、增压中冷柴油发动机。
 额定功率 :194kW/2400rpm。
 最大扭矩 :990N·m/1500rpm。

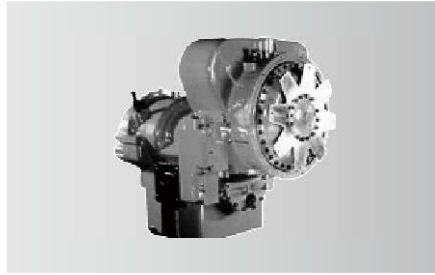

Transmission

Dana electronically controlled auto transmission features 6 speeds forward and 6 speeds reverse, wide ratio range, and smooth gearshift with reduced maintenance cost.

变速箱

德纳全自动电控变速箱,6个前进挡、6个后退挡,速比范围大,换挡平顺无冲击,维修保养成本低。

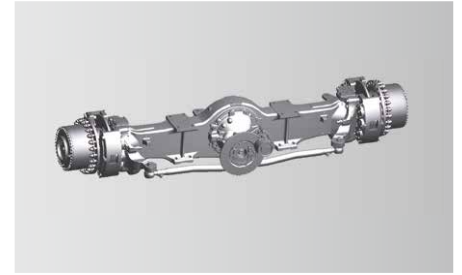

Axle and suspension

Both axles are driven and steered. Front axle is mounted to the frame by independent steel plate, and rear adopts oscillation cylinders with hydraulic lockout. Driving comfort and lateral stability is therefore guaranteed on rough terrains and conditions.

车桥悬挂

前后桥均为驱动桥和转向桥。前桥采用独立式钢板连接,后桥采用摆动支架式,液压油缸闭锁悬架系统;能适用各种恶劣工况和路面,保证车辆行驶的平顺性和侧翻稳定性,驾驶舒适。

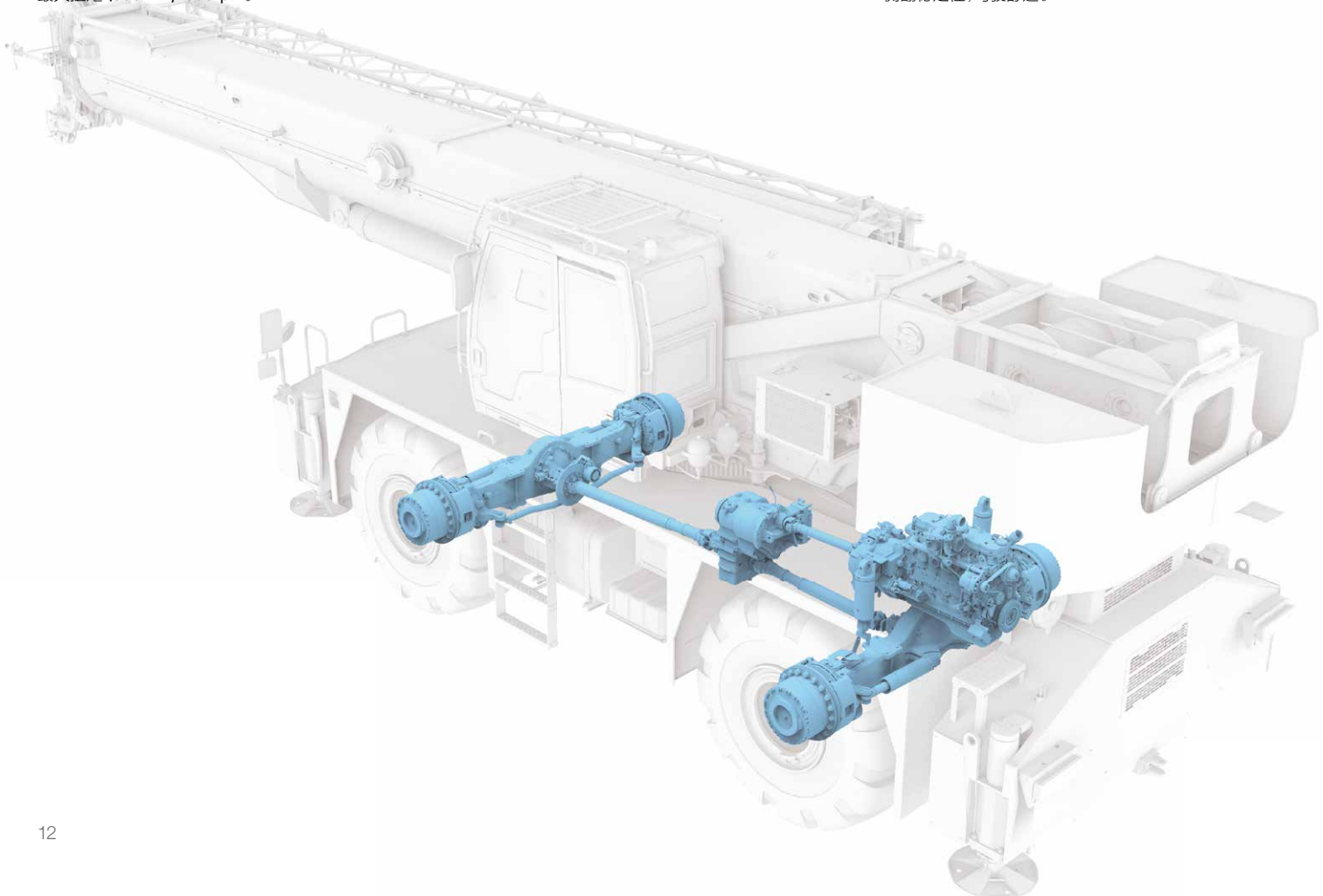

Electrical System

电气系统

Smart CAN-BUS communication system

International advanced CAN-BUS data communication network applied for display, instrument panel, I/O module, joysticks and main sensors, allowing for high-speed data transmission and quick response in less than 20ms.

Winch camera (optional)

Winch cameras equipped for monitoring its working condition and identifying rope disorder in time.

Integrated bus button panel input

Various operating states displayed by button indicator lights, and one-button multi-functional operation realizable by writing various operation modes.

智能总线通信系统

国际先进的分布式集成总线数据通信网络，显示器、显示仪表、I/O 模块、操作手柄、主要传感器等采用 CAN 总线组网，高速信息传输、响应速度小于 20ms。

卷扬监控系统(选配)

卷扬摄像头监视卷扬工作及及时发现乱绳的情况。

集成总线按键面板输入

可通过按键指示灯显示各种工作状态，通过写入多种操作模式实现一键多功能。



Centralized electric cabinet
集中式电控箱



Anti-two-block switch
高度限位器



Third wrap indicator
三圈保护器



Cable reel
电缆卷筒



Anemometer
风速仪

Multi-functional screen

Large 10.1 inch HD touch screen display with all new interface. Incorporated crane setup, load charts, working conditions, working period, virtual wall, Bluetooth, radio and diagnostics with an additional navigation knob.

Precise load moment indicator

SANY independently developed LMI, accuracy of 0 ~ 5%.

高新多功能显示屏

采用 10.1 寸高清显示屏, 全新操作界面, 可实现触摸与旋钮多种方式操控。工况、力矩、发动机、变速箱、控制器 IO 点、工作时间统计等丰富的设备状态信息呈现, 集成虚拟墙、蓝牙、收音机等多种扩展功能。

精准力矩器系统

三一自主研发的力矩限制器系统, 精度达 0~5%。

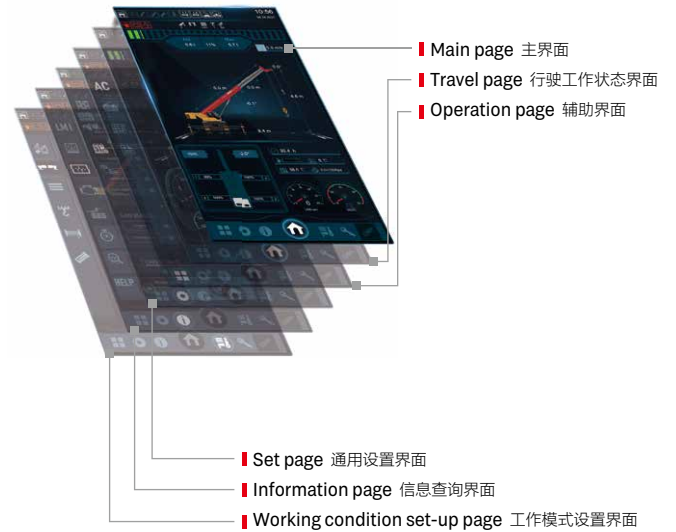

MachineLink⁺

ROOTCLOUD T-AMS Pro device comes as standard to realize GPS trajectory, machine status, maintenance management, E-fence, alarm management, and operator management on computer or mobile MachineLink+ platform, by remote control of cranes. This telematics package greatly boosts efficiency of customer fleet management and helps provide better after-sales services.

标配树根物联终端 T-AMS Pro, 通过对起重机设备的远程控制, 在电脑或移动端 MachineLink+ 平台实现轨迹回放、设备状态、维保设备、电子围栏、报警管理、操作手管理等功能, 极大提高客户设备管理效率, 提升三一售后服务能力。

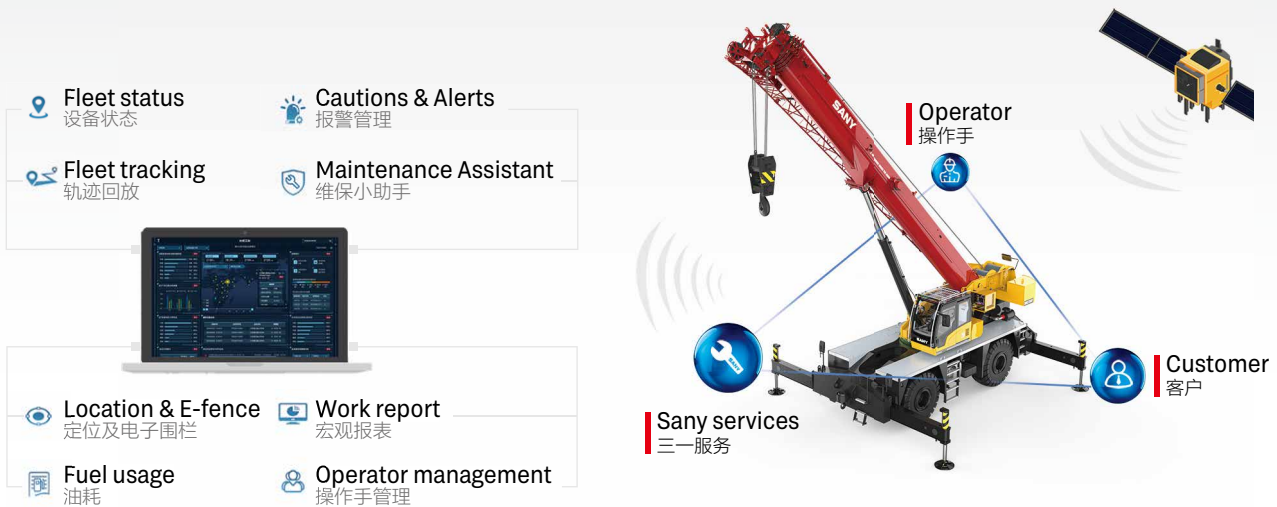

Hydraulic System

液压系统

Four boom sections extended by double cylinder with rope arranger, 2nd boom extended by cylinder I, 3rd ~5th sections telescoped by cylinder II with rope pull. Synchronized telescoping of variable lengths for more applications with higher efficiency.

5节主臂,双缸绳排,1号油缸和钢丝绳伸2节臂,2号油缸和钢丝绳伸3、4、5节臂,可实现同步伸缩,臂长任意组合,省时省力。



Telescoping mode I
伸缩模式 1

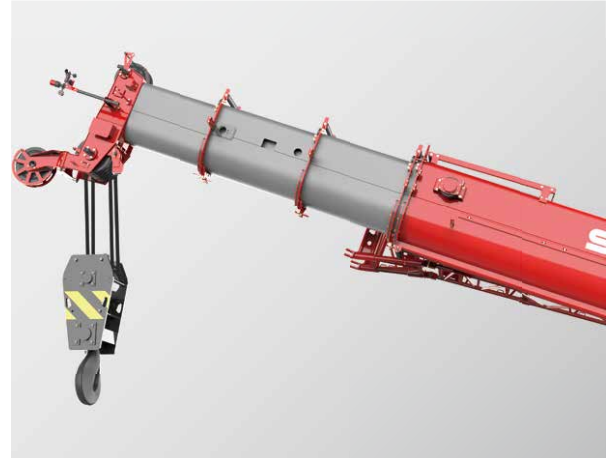

Telescoping mode II
伸缩模式 2

Superstructure

上车

Open-type electronically controlled load-sensing system and dynamic slewing brake system.

Electro proportional compensated passive luffing-down system applied to control the luffing speed, making luffing more reliable and stable.

Dynamic slewing brake realizing precise control of slewing speed.

Electronically controlled load-sensing hydraulic system, electronic joystick and electronic throttle, ensuring easy operation and more accurate control and millisecond-level action response speed, with min. single-rope hoisting speed 0.8m/min, and distribution difference in case of combined motions 8%.

通过开式电控负载敏感系统和动态回转制动系统；

电比例自重落幅系统控制落幅速度,更可靠更平稳；

具备动态回转制动功能,可实现回转速度精准控制；

电控负载敏感液压系统,采用电手柄、电油门控制,轻松操作的同时,控制更精准；动作响应毫秒级速度；卷扬单绳最低速度 0.8m/min；复合动作分配误差 8%。

Chassis

下车

Steering system

A gear pump installed to supply oil for hydraulic steering, steering pressure controlled by electro-proportional relief valve, four steering modes realized by solenoid directional valve.

Suspension system

Different modes including normal driving and Pick & Carry with suspension locked, suspension to be locked when the crane is working.

Outrigger telescoping system

The electro proportional relief valve identifies pressure staging of outrigger telescoping, satisfying operation requirements under high pressure and forming protection under limited pressure.

转向系统

液压转向系统采用齿轮泵提供油源,通过电比例溢流阀精确控制转向压力,通过电磁换向阀实现前轮转向,后轮转向,全轮转向和蟹行转向共计四种转向模式。

悬挂系统

悬挂系统通过选择不同的悬挂模式可以实现正常行驶和锁定模式下的带载行驶;在起重机上车作业时能够对悬挂进行锁定。

支腿伸缩系统

支腿伸缩采用电比例溢流阀对支腿伸缩进行压力分级,既满足高压动力动作需求,也可满足限压保护功能。

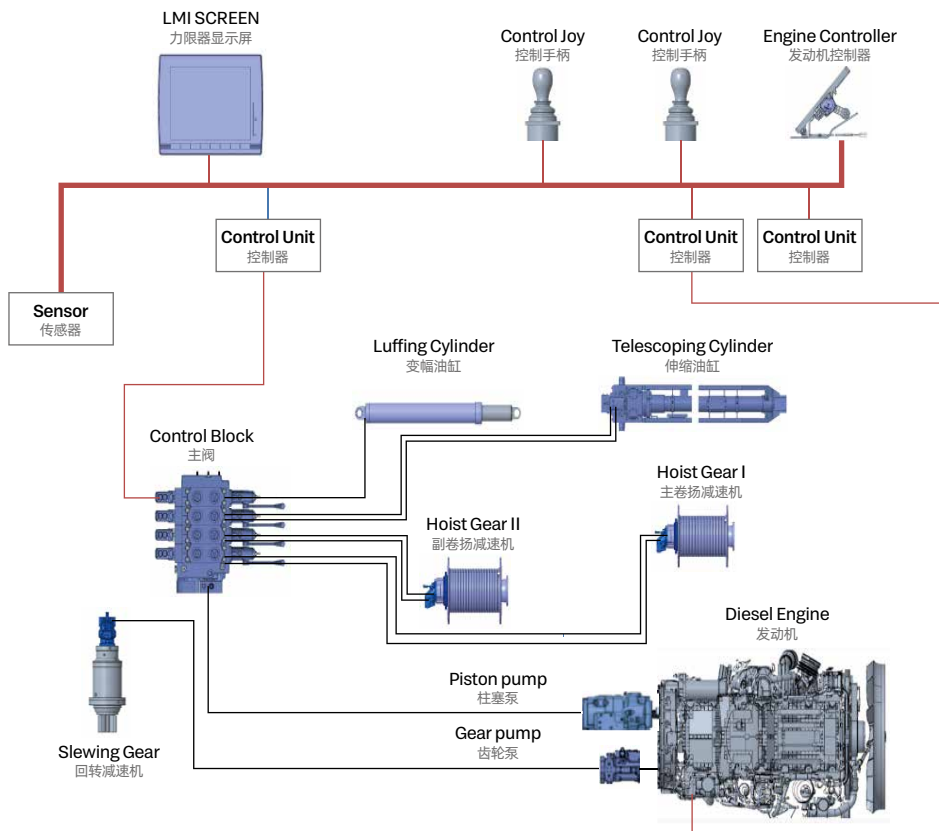

Overall Dimensions

整机尺寸

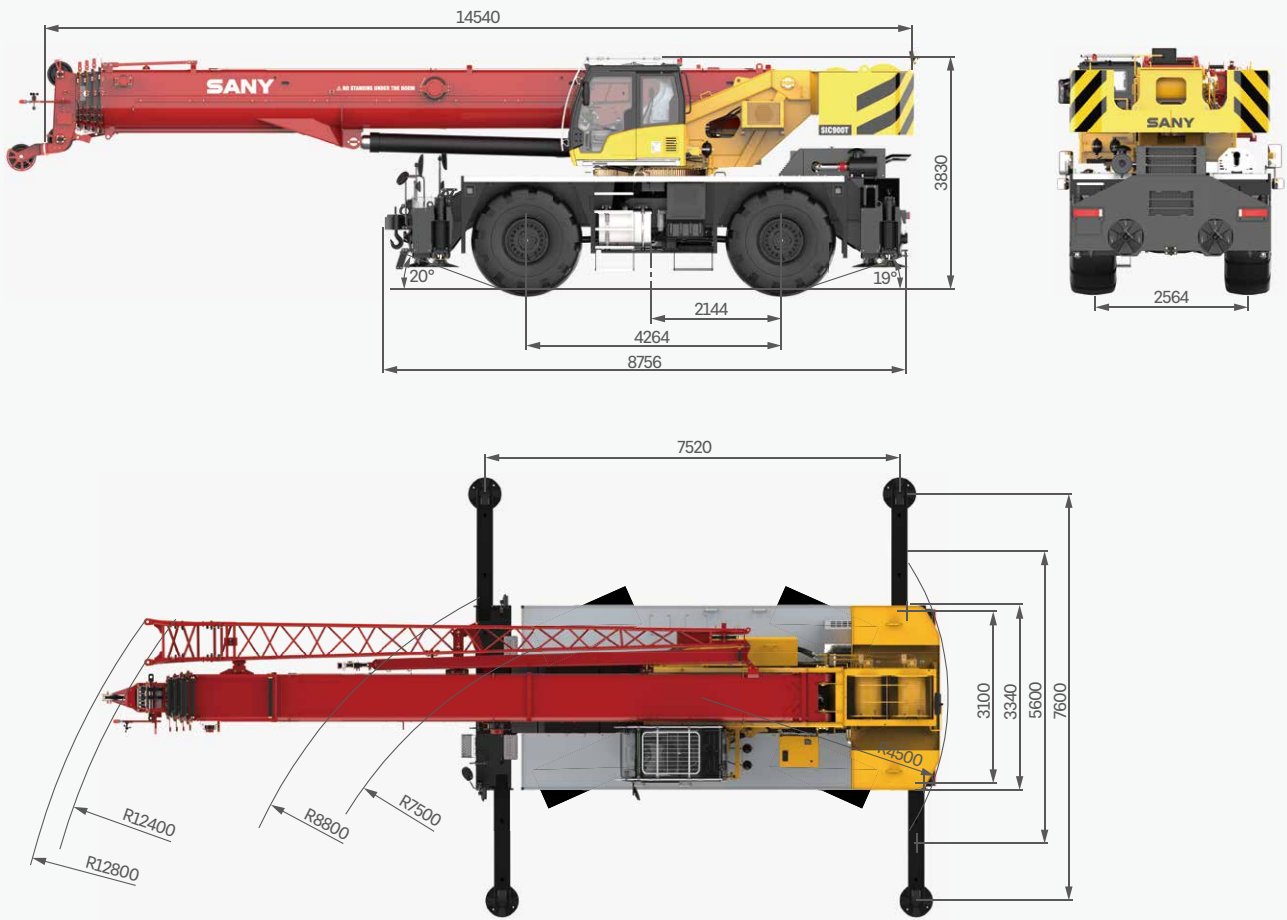

Technical Specification

整机参数

CATEGORY 类型	ITEM 项目	UNIT 单位	VALUE 参数	
CAPACITY 额定起重量	Max. lifting capacity 最大起重量	t	90	
WEIGHT 重量参数	Gross weight 整机总质量	kg	54000	
POWER 发动机参数	Engine model 发动机型号	-	QSB6.7 (Stage III)	
	Max. engine power 发动机最大功率	kW/rpm	194/2400	
	Max. engine torque 发动机最大输出扭矩	N·m/rpm	990/1500	
DIMENSIONS 尺寸参数	Overall length 整机全长	mm	14540	
	Overall width 整机全宽	mm	3340	
	Overall height 整机全高	mm	3830	
TRAVEL 行驶参数	Max. travel speed 最高行驶速度	km/h	35	
	Steering radius 转弯半径	Min.steering radius 最小转弯半径	m	7.5
		Min.steering radius of boom tip 臂头最小转弯半径	m	12.8
	Wheel formula 车轮模式	-	4 × 2; 4 × 4	
	Min.ground clearance 最小离地间隙	mm	530	
	Approach angle 接近角	°	20	
	Departure angle 离去角	°	19	
	Max.gradeability 最大爬坡度	-	75%	
	Fuel consumption per 100km 每 100 公里油耗	L	100	
	MAIN PERFORMANCE 主要性能参数	Working temperature range 使用温度区间	℃	-20~+46
Min.rated lifting radius 最小额定幅度		m	2.5	
Tail slewing radius 转台尾部回转半径		m	4.5	
Boom sections (Qty.) 臂节数		-	5	
Boom shape 臂形状		-	U shape U 型	
Max.lifting moment 最大起重力矩		Basic boom 基本臂	kN·m	2940
		Full-extension boom 全伸主臂	kN·m	1442
		Full-extension boom + jib 全伸主臂 + 副臂	kN·m	668
Boom length 臂长		Basic boom 基本臂	m	12.2
		Full-extension boom 全伸主臂	m	47
		Full-extension boom + jib 全伸主臂 + 副臂	m	65
Max.lifting height 最大起重高度		Basic boom 基本臂	m	13
		Full-extension boom 全伸主臂	m	47.5
		Full-extension boom + jib 全伸主臂 + 副臂	m	65.5
Outrigger span (Longitudinal × Transverse) 支腿跨距 (纵 × 横)		m	7.52 × 7.6	
Jib offset 副臂安装角度	°	0, 20, 40		
AIRCONDITIONER 空调	In operator's cab 上车空调	-	Heating & cooling 制冷、制热	

Technical Specification

整机参数



Axle Load 轴荷

Axle 轴	1	2	Gross weight 总重量
Axle load 轴荷 /kg	27200	26800	54000
Remark 备注	Boom angle 0°, with full water and fuel reservoirs, main hook, and aux. hook. 起重臂角度 0°、满水、满油、主钩、副钩		



Hook 吊钩

Rated load 额载 /t	Number of sheaves 滑轮数量	Rope rate 倍率	Hook weight/kg 吊钩重量
70	5	10	690
8	-	1	160



Operations 主要动作参数

Item 项目	Max. single rope lifting speed (empty load) 单绳速度 (空载)	Rope diameter/length 钢丝绳直径 / 长度	Max. single line pull 最大单绳拉力
Main winch 主卷扬	150m/min	Φ 20mm/250m	8.3t
Auxiliary winch 副卷扬	150m/min	Φ 20mm/145m	8.3t
Slewing speed 回转速度	1.8r/min		
Full luffing up/down time of boom 主臂起落幅时间	90s/95s		
Full extension/retraction time of boom 主臂伸缩时间	120s/125s		
Outrigger jack 垂直支腿	Extension 伸	35s	
	Retraction 缩	40s	
Outrigger beam 水平支腿	Extension 伸	30s	
	Retraction 缩	25s	

Crane Introduction

整机介绍

Carrier 下车

Carrier frame 车架

- Double longitudinal beam construction welded by high strength steel plate, higher bearing capacity.
- 车架为高强度钢板焊接而成的双纵梁结构，承载能力强。

Engine 发动机

- Model: DF Cummins QSB6.7 inline six-cylinder diesel engine with watercooler and inter cooler.
- Rate power: 194kW/2400rpm.
- Emission standard: Stage III.
- Fuel reservoir capacity: 350L.
- 型号：东风康明斯 QSB6.7 直列六缸、水冷却、增压中冷、柴油发动机。
- 额定功率：194kW/2400rpm。
- 排放标准：符合 III 阶段。
- 油箱容积：350L。

Transmission 变速箱

- Auto-transmission, 6 forward gears and 6 reverse gears, large speed ratio range, adaptable to slope climbing and high-speed traveling.
- 自动变速箱，变速箱有 6 个前进档、6 个后退档，速比范围大，即可满足低速场地爬坡行驶又可满足高速行驶。

Axle 车桥

- Two axle chassis of flexible maneuverability, four-wheel drive, excellent dynamic performance.
- 操控灵活，底盘两桥设计，前、后桥驱动，动力性能好。

Suspension system 悬挂

- The front is rigidly mounted, and the rear axle adopts pivot oscillation suspension with hydraulic lockout.
- 前桥刚性连接，后桥带油缸锁定枢轴摆动悬挂。

Tires 轮胎

- Large diameter off-road 29.5-25 tires deliver large ground clearance and strong off-road agility.
- 大直径越野轮胎，离地间距大，越野性能强，轮胎型号 29.5-25。

Braking 制动系统

- Dual circuit braking system. When one circuit fails, the other can still work normally, improving the safety and reliability of the braking system.
- 双回路制动系统，当某一回路出现故障时，另一回路仍能正常工作，提高制动系统的安全性和可靠性。

Hydraulics 液压系统

- Adopt stable and high-quality main oil pump, enhancing system reliability. Precise parameter matching contributes to superior controllability of the vehicle.
- 采用稳定、高品质的主油泵，系统可靠性高；通过精确的参数匹配，操控性能优越。

Outrigger 支腿

- H-type telescoping outrigger, 4-point support, with span (longitudinal × transverse) 7.52m × 7.6m.
- 采用 H 形伸缩支腿，4 点支撑，纵、横跨距 7.52m × 7.6m。

Control system 控制系统

- CAN-BUS: The bus instrument of integrated intelligent control electrical system can display driving parameters at any time, making driving easier. At the same time, engine failure prompt makes the maintenance and troubleshooting more convenient and faster.
- All-round safety protection, the main and auxiliary hoists are equipped with three-circle indicators and A2B switches to prevent over-hoist-down and over winding of the wire ropes.
- Load moment indicator: It adopts highly intelligent moment indicator system to fully protect lifting operation and ensure accuracy, stability and comfort.
- 总线仪表：采用集成一体智能控制电气系统的总线仪表，可随时掌控行驾参数，驾乘轻松；同时拥有发动机故障提示功能，维修排故方便、快捷。
- 全方位的安全保护系统，主、副卷扬配置三圈保护器和高度限位器，防止钢丝绳过放和过卷，防倾翻保护，极限角度保护。
- 力 limiter：采用高度智能力矩限制器系统，全方位保护吊载作业，确保操作精准、平稳、舒适。

Crane Introduction

整机介绍

Operator's cab 操纵室

- New generation T-series operator's cab features curved-rail sliding door, safety glass and corrosion resistant steel construction with softened interior trim. Large internal space with panoramic skylight, adjustable seat and other user-friendly design incl. A/C, electric wiper, making it more comfortable and easier to work. The LMI screen is equipped to realize the logic integration of the control console and the display, so that all working data can be seen at a glance.
- 全新一代 T 系列操纵室，带变轨滑移门，配备安全玻璃，耐腐蚀钢板，配置软化内饰、超大内部空间、可调式座椅等人性化设计，配有空调、电动雨刮器，操作更舒适、轻松；配置力矩限制器显示屏，实现主控台与操作显示系统有机结合，使吊装作业的全部工况数据一目了然。

Boom system 臂架系统

- Boom: Five-section, basic boom 12.2m, full-extension 47m, made of high-strength welded structural steel with U-shape cross-section.
- Jib: Two-section, 10.5m / 18m, offset at 0°, 20°, 40°.
- 主臂：五节臂，基本臂 12.2m，全伸臂 47m，由高强度焊接结构钢制成，U 形截面。
- 副臂：两节副臂，分别为 10.5m 和 18m，安装角度为 0°，20°，40°。

Slewing platform 转台结构

- SANY independently developed, made of fine grain high strength steel in optimized structure.
- 三一自主设计，结构更优化，由细晶粒高强度钢制成。

Hydraulics 液压系统

- Load sensing variable piston pump can adjust displacement in real time to achieve high precision flow control, greatly reducing energy loss.
- Winch adopts electronically controlled variable motor with high operation efficiency. Max. single rope speed of main and auxiliary winch is 150m/min.
- Slewing system integrating slewing buffer and free swing technology, start & brake process is smoother and the inching motion performance is ever better.
- 采用负载敏感变量柱塞泵，能实时调节油泵排量，实现高精度的流量控制，极大的降低能量损耗。
- 卷扬采用电控变量马达，作业效率高；主、副卷扬单绳速度最大达150m/min。
- 回转系统带集成回转缓冲阀，具有自由滑转功能，回转启动和控制平稳，微动性卓越。

Hoist 起升机构

- Pump and motor double variable speed regulation, highly efficient and energy saving. Balance valve and unique anti-hook-slip technology are perfectly coupled to achieve smooth rise and fall of the load. Non-rotation high strength wire rope is used.
- 泵、马达双变量调速，高效节能。卷扬平衡阀与独特的防溜钩技术完美结合，重物起落平稳。配备防旋转高强度钢丝绳。

Luffing system 变幅系统

- Double acting single rod hydraulic cylinder with balance valve, luffing angle: -2°~80°. Passive luffing down, reducing energy consumption, improving luffing stability.
- 双作用单活塞杆液压缸，带安全平衡阀，变幅角度：-2°~80°，采用自重落幅系统，降低能耗，提高落幅操作的平稳性。

Slewing 回转系统

- 360° slewing in both directions, max. speed 1.8r/min. It adopts electro proportional speed control for stable movement and system reliability. The unique slewing balance design makes the braking smoother.
- 360° 转动，最大回转速度 1.8r/min。液控比例调速控制，动作稳定，系统可靠。独特的回转缓冲设计，制动更平稳。

Counterweight 配重

- Fixed block 9.5t.
- 固定配重 9.5t。

Safety equipment 安全装置

- Load moment indicator: Analytical mechanics is applied and moment limiter calculation system based on the hoisting mechanics model is established. Through online empty-load calibration, the rated accuracy can reach 0-5% to fully protect the hoisting operation. In case of overload, the system will automatically give an alarm to guarantee safety operation.
- The hydraulic system includes balance valve, relief valve, two-way holding valve, etc. to realize system stability and reliability.
- The main and auxiliary winches are equipped with third-wrap indicators to prevent over-hoist-down of the wire rope.
- Boom head and jib head are equipped with A2B switches to prevent the wire rope from over winding.
- The length & angle sensor and pressure sensor are equipped to signify working status in real time, automatically stopping hazardous actions with buzzer alarm.
- 力矩限制器：采用分析力学方法，建立了基于吊重力学模型的力矩限制器计算系统，通过在线空载标定，额定吊重精度达到 0-5%，全方位保护吊载作业；超载作业时，系统自动报警提示，为操纵作业提供安全保障。
- 液压系统配置平衡阀、溢流阀、双向液压锁等元件，实现液压系统稳定可靠。
- 主、副卷扬配置三圈保护器，防止钢丝绳过放。
- 主、副臂臂端配置高度限位器，防止钢丝绳过卷。
- 配置长度角度传感器、压力传感器，实时显示起重机作业状态，自动切断危险动作，蜂鸣报警。

Optional equipment at extra fees 选配

- Boom tip camera / Winch camera / Reversing camera & image / Data recorder / Outrigger pad / Outrigger pad bracket / Spark arrester / Air intake shutoff valve / Reversing radar / Fire extinguisher bracket / Desert tires / Customized painting
- Other equipment available upon request
- 臂尖摄像头 / 卷扬摄像头 / 倒车摄像头影像 / 数据记录仪 / 支腿垫板 / 支腿垫板托架 / 火星灭火器 / 发动机进气关断阀 / 倒车雷达 / 灭火器支架 / 沙漠胎 / 特殊涂装
- 其他选配视需求定

Working Conditions

工况组合



Telescopic boom on outriggers
主臂、支腿吊载

Fixed jib on outriggers
固定副臂、支腿吊载

Telescopic boom on tires
主臂、轮胎吊载

Operating Range - Telescopic Boom

起升高度曲线 - 主臂

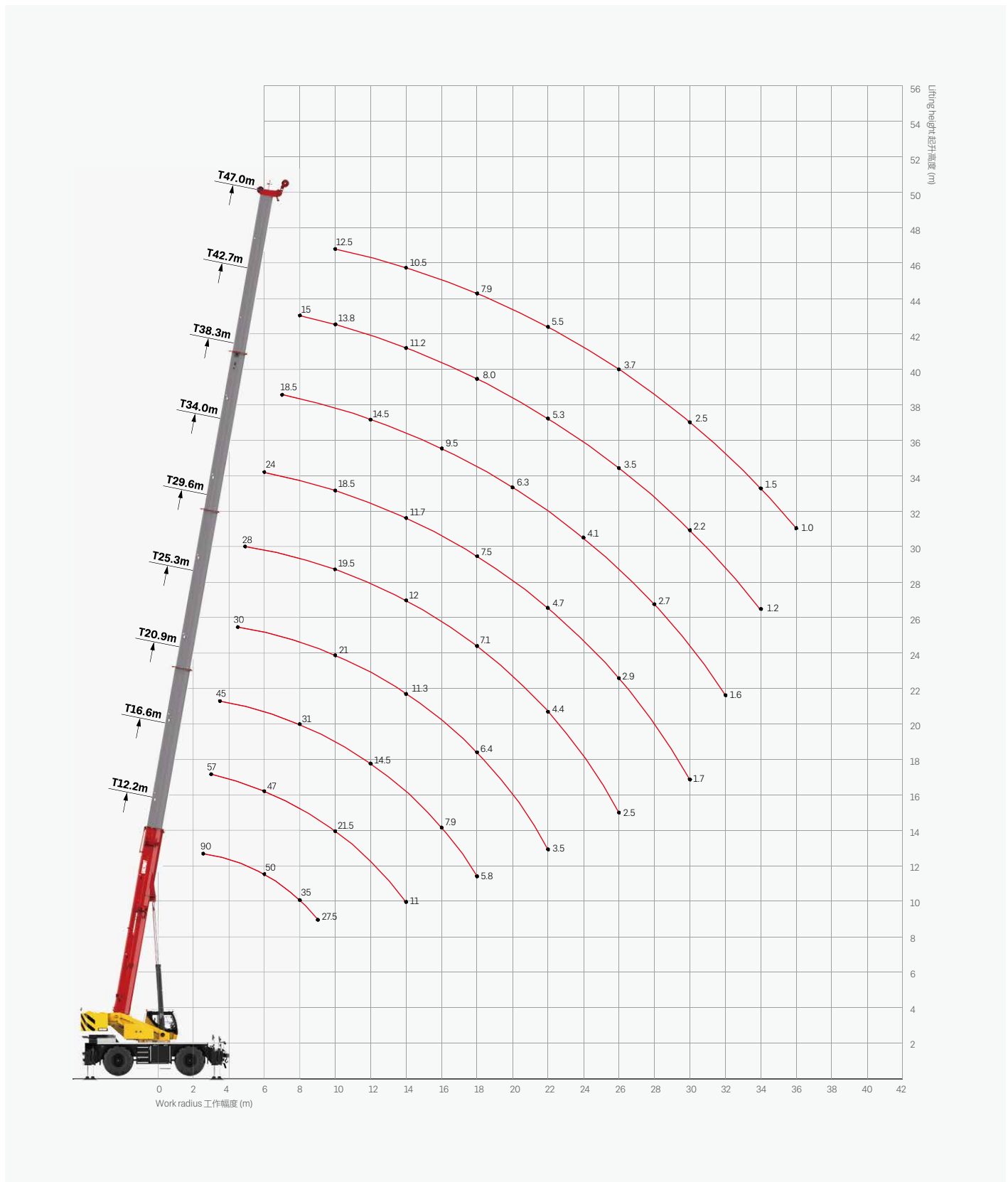









Load Chart-Telescopic Boom

性能表 - 主臂

Unit: kg











	12.2	16.6	16.6	20.9	20.9	20.9	25.3	25.3	25.3	29.6		
2.5	90000										2.5	
3.0	85000	31000	57000								3.0	
3.5	75000	31000	55000	29000	30500	45000					3.5	
4.0	68000	31000	54000	29000	30500	45000					4.0	
4.5	63000	31000	53000	29000	30500	45000	26000	28500	30000		4.5	
5.0	58000	31000	52000	29000	30500	43000	26000	28500	30000	20000	5.0	
5.5	54000	30500	50000	28000	30500	41000	26000	28500	30000	20000	5.5	
6.0	50000	30000	47000	27000	29500	39000	26000	28000	29500	20000	6.0	
6.5	46000	29500	43000	26000	29000	37000	25000	27000	29000	20000	6.5	
7.0	42000	29000	39500	25000	28000	35000	24000	25500	28000	19500	7.0	
8.0	35000	28000	33000	24000	25000	31000	22000	23500	25000	18500	8.0	
9.0	27500	26500	27000	22500	23000	26000	21000	21500	23500	17500	9.0	
10.0		23500	21500	21000	21000	22000	19000	19500	21000	16500	10.0	
11.0		19600	17700	19000	18000	17300	18000	17500	18000	15500	11.0	
12.0		16700	14900	17300	16000	14500	15800	15500	15500	14500	12.0	
14.0		12000	11000	13200	11800	10500	13000	12500	11300	12200	14.0	
16.0				10200	9000	7900	10600	9700	8500	10800	16.0	
18.0				8100	6800	5800	8500	7500	6400	8900	18.0	
20.0							6800	6000	4900	7300	20.0	
22.0							5600	4800	3500	6000	22.0	
24.0										5000	24.0	
26.0										4200	26.0	
28.0											28.0	
30.0											30.0	
32.0											32.0	
34.0											34.0	
36.0											36.0	
38.0											38.0	
	12	6	8	4	6	6	4	4	4	4		
	2#	0%	0%	50%	0%	50%	100%	0%	50%	100%	0%	2#
	3#	0%	17%	0%	33%	17%	0%	50%	33%	17%	67%	3#
	4#	0%	17%	0%	33%	17%	0%	50%	33%	17%	67%	4#
	5#	0%	17%	0%	33%	17%	0%	50%	33%	17%	67%	5#
	0	0	0	0	0	0	0	0	0	0	0	
	18000	10000	9000	6000	4500	4000	4500	3500	2000	2500		

Load Chart-Telescopic Boom

性能表 - 主臂

Unit: kg















	29.6	29.6	34.0	34.0	34.0	38.3	38.3	38.3	42.7	42.7	47.0		
2.5												2.5	
3.0												3.0	
3.5												3.5	
4.0												4.0	
4.5												4.5	
5.0	25000	28000										5.0	
5.5	25000	28000										5.5	
6.0	25000	28000	18000	19000	24000							6.0	
6.5	25000	27000	18000	19000	24000							6.5	
7.0	24500	25500	18000	19000	23500	15000	16000	18500				7.0	
8.0	22500	23000	17000	18500	21500	15000	16000	18500	14000	15000		8.0	
9.0	20500	21000	16000	18000	20000	14000	15500	17500	14000	14500		9.0	
10.0	19500	19500	14500	17500	18500	13000	15000	17000	13500	13800	12500	10.0	
11.0	18000	17500	13500	16500	17000	12000	14000	15500	12500	12800	12000	11.0	
12.0	16000	15300	12500	15000	15200	11000	12500	14500	11500	12000	11500	12.0	
14.0	12500	12000	11000	11500	11700	9500	11300	11500	10300	11200	10500	14.0	
16.0	9900	9200	9500	9700	9500	8500	9600	9500	9300	9300	9200	16.0	
18.0	7800	7100	8500	8200	7500	7700	8500	7800	8200	8000	7900	18.0	
20.0	6300	5600	7400	6600	5900	7000	6900	6300	7100	6500	6700	20.0	
22.0	5100	4400	6100	5400	4700	6300	5700	5100	5900	5300	5500	22.0	
24.0	4200	3400	5100	4400	3700	5300	4700	4100	4900	4300	4500	24.0	
26.0	3400	2500	4300	3600	2900	4500	3900	3300	4100	3500	3700	26.0	
28.0			3600	2900	2300	3800	3200	2700	3400	2800	3100	28.0	
30.0			3000	2300	1700	3200	2600	2100	2800	2200	2500	30.0	
32.0						2700	2100	1600	2300	1700	2000	32.0	
34.0						2300	1700		1900	1200	1500	34.0	
36.0									1500		1000	36.0	
38.0									1200			38.0	
	4	4	4	4	4	4	4	4	4	4	3		
	2#	50%	100%	0%	50%	100%	0%	50%	100%	50%	100%	100%	2#
	3#	50%	33%	83%	67%	50%	100%	83%	67%	100%	83%	100%	3#
	4#	50%	33%	83%	67%	50%	100%	83%	67%	100%	83%	100%	4#
	5#	50%	33%	83%	67%	50%	100%	83%	67%	100%	83%	100%	5#
		0	0	0	0	0	0	18	26	18	31	35	
		2000	1500	1500	1000	800	1000	800	800	800	800	800	

Load Chart-Telescopic Boom

性能表 - 主臂

Unit: kg



	12.2	16.6	16.6	20.9	20.9	20.9	25.3	25.3	25.3	29.6	
3.0	75000	29000	53000								3.0
3.5	65000	29000	51000	27000	28500	42000					3.5
4.0	60000	29000	49000	27000	28500	42000					4.0
4.5	54600	29000	48000	27000	28500	42000	24000	26500	28000		4.5
5.0	45200	29000	44000	27000	28500	40000	24000	26500	28000	18000	5.0
5.5	36500	29000	36000	26000	28000	35500	24000	26500	28000	18000	5.5
6.0	30300	28000	30000	25000	27000	29500	24000	26500	28000	18000	6.0
6.5	25700	27000	25000	24000	26000	25000	22500	25000	25700	18000	6.5
7.0	22200	23300	21500	23000	22400	21500	21500	23200	22200	18000	7.0
8.0	17100	18100	16500	18700	17200	16500	19000	18000	17100	17000	8.0
9.0	13600	14500	13000	15100	13700	13000	15500	14500	13500	15800	9.0
10.0		12000	10500	12500	11200	10500	12900	12000	11000	13200	10.0
11.0		10000	8600	10500	9300	8500	11000	10000	9100	11200	11.0
12.0		8500	7100	9000	7800	7000	9300	8500	7600	9600	12.0
14.0		6000	4900	6700	5600	4600	7000	6200	5400	7300	14.0
16.0				5100	4100	3200	5400	4600	3800	5600	16.0
18.0				3900	2900	1900	4200	3400	2600	4400	18.0
20.0							3300	2500	1800	3500	20.0
22.0							2600	1800		2800	22.0
24.0										2200	24.0
26.0										1700	26.0
28.0											28.0
30.0											30.0
	10	4	8	4	4	6	4	4	4	4	
	0%	0%	50%	0%	50%	100%	0%	50%	100%	0%	2#
	0%	17%	0%	33%	17%	0%	50%	33%	17%	67%	3#
	0%	17%	0%	33%	17%	0%	50%	33%	17%	67%	4#
	0%	17%	0%	33%	17%	0%	50%	33%	17%	67%	5#
	0	0	0	0	0	0	0	0	28	17	
	10000	5000	3500	2500	1500	1000	1500	1000	800	800	

Load Chart-Telescopic Boom

性能表 - 主臂

Unit: kg











	29.6	29.6	34.0	34.0	34.0	38.3	38.3	38.3	42.7	42.7	47.0	
3.0												3.0
3.5												3.5
4.0												4.0
4.5												4.5
5.0	23500	26000										5.0
5.5	23500	26000										5.5
6.0	23500	26000	16500	17000	23000							6.0
6.5	23500	25000	16500	17000	22500							6.5
7.0	22000	22000	16500	17000	22000	14000	15000	16000				7.0
8.0	18500	17700	16000	17000	18200	14000	15000	16000	13000	14000		8.0
9.0	15000	14100	15000	15300	14600	13000	14000	15000	13000	13000		9.0
10.0	12400	11600	13400	12700	12000	12000	13000	12400	12000	12000	11000	10.0
11.0	10400	9600	11400	10700	10000	11000	11000	10400	11000	10600	10500	11.0
12.0	8800	8100	9800	9100	8400	10000	9300	8800	9500	9000	9200	12.0
14.0	6500	5900	7500	6800	6200	7700	7000	6500	7200	6600	6900	14.0
16.0	4900	4300	5800	5200	4600	6000	5400	4900	5600	5000	5300	16.0
18.0	3700	3100	4600	4000	3400	4700	4200	3700	4400	3800	4100	18.0
20.0	2800	2200	3600	3100	2500	3800	3300	2800	3500	2900	3200	20.0
22.0	2200	1500	2900	2400	1800	3100	2600	2100	2800	2200	2500	22.0
24.0	1600		2300	1800	1200	2500	2000	1500	2200	1600	1900	24.0
26.0			1800	1300		2000	1500		1700	1100	1300	26.0
28.0			1300			1600			1300			28.0
30.0						1200						30.0
	4	4	4	4	4	4	4	4	4	4	3	
	50%	100%	0%	50%	100%	0%	50%	100%	50%	100%	100%	2#
	50%	33%	83%	67%	50%	100%	83%	67%	100%	83%	100%	3#
	50%	33%	83%	67%	50%	100%	83%	67%	100%	83%	100%	4#
	50%	33%	83%	67%	50%	100%	83%	67%	100%	83%	100%	5#
	27	35	26	33	39	32	42	46	44	48	52	
	800	800	800	800	800	800	800	800	800	800	800	

Load Chart-Telescopic Boom

性能表 - 主臂

Unit: kg



	12.2	16.6	16.6	20.9	20.9	20.9	25.3	25.3	25.3	29.6	
3.0	51000		50500								3.0
3.5	37000	27000	36200		26000	30000					3.5
4.0	28700	26000	28000	25000	25000	27700					4.0
4.5	23000	24000	22400	24600	23300	22100	22000	22500	23000		4.5
5.0	19000	20000	18400	20500	19300	18100	21000	19800	19000	17000	5.0
5.5	16000	17000	15400	17400	16300	15100	18000	16800	16000	17000	5.5
6.0	13700	14600	13100	15000	13900	12800	15500	14500	13700	15800	6.0
6.5	11800	12700	11300	13100	12000	11000	13600	12600	11800	13900	6.5
7.0	10300	11100	9800	11500	10500	9500	12000	11100	10300	12300	7.0
8.0	8000	8800	7500	9200	8200	7200	9600	8700	8000	9900	8.0
9.0	6500	7000	5800	7400	6500	5500	7800	7000	6200	8100	9.0
10.0		5700	4500	6100	5100	4200	6400	5700	4900	6700	10.0
11.0		4700	3500	5100	4100	3200	5400	4600	3900	5700	11.0
12.0		3800	2700	4200	3300	2400	4500	3800	3100	4800	12.0
14.0				2900	2100	1200	3200	2500	1800	3500	14.0
16.0				2000	1200		2300	1600		2500	16.0
18.0				1200			1600			1800	18.0
20.0										1200	20.0
22.0											22.0
24.0											24.0
26.0											26.0
	8	4	8	4	4	4	4	4	4	4	
2#	0%	0%	50%	0%	50%	100%	0%	50%	100%	0%	2#
3#	0%	17%	0%	33%	17%	0%	50%	33%	17%	67%	3#
4#	0%	17%	0%	33%	17%	0%	50%	33%	17%	67%	4#
5#	0%	17%	0%	33%	17%	0%	50%	33%	17%	67%	5#
	0	0	0	15	30	40	37	44	50	42	
	4000	1500	800	800	800	800	800	800	800	800	
	71	74	77	76	79	80	77	80	80	79	

Load Chart-Telescopic Boom

性能表 - 主臂

Unit: kg



	29.6	29.6	34.0	34.0	34.0	38.3	38.3	38.3	42.7	42.7	47.0	
3.0												3.0
3.5												3.5
4.0												4.0
4.5												4.5
5.0	20000	19700										5.0
5.5	17500	16600										5.5
6.0	15000	14200	15000	15500	14700							6.0
6.5	13000	12300	14100	13500	12800							6.5
7.0	11500	10700	12500	11900	11200	12000	12100	11500				7.0
8.0	9100	8400	10100	9500	8800	10300	9700	9100	9500	9300		8.0
9.0	7400	6600	8300	7700	7100	8500	7900	7400	8100	7600		9.0
10.0	6000	5300	6900	6300	5700	7100	6500	6000	6700	6200	6400	10.0
11.0	5000	4300	5900	5300	4700	6000	5500	5000	5700	5200	5400	11.0
12.0	4100	3500	5000	4400	3800	5100	4600	4100	4800	4300	4500	12.0
14.0	2800	2200	3700	3100	2500	3800	3300	2800	3500	3000	3200	14.0
16.0	1900	1300	2700	2200	1600	2800	2300	1900	2500	2000	2200	16.0
18.0	1200		2000	1500		2100	1600		1800	1300	1500	18.0
20.0			1400			1500						20.0
22.0												22.0
24.0												24.0
26.0												26.0
	4	4	4	4	4	4	4	4	4	4	3	
	50%	100%	0%	50%	100%	0%	50%	100%	50%	100%	100%	2#
	50%	33%	83%	67%	50%	100%	83%	67%	100%	83%	100%	3#
	50%	33%	83%	67%	50%	100%	83%	67%	100%	83%	100%	4#
	50%	33%	83%	67%	50%	100%	83%	67%	100%	83%	100%	5#
	47	52	49	53	57	54	57	60	60	61	64	
	800	800	800	800	800	800	800	800	800	800	800	
	80	80	80	80	80	80	80	80	80	80	80	

Remark

1. Load capacity in the chart is the maximum weight which this crane could hoist include the weight of hook blocks and riggings. The main hook weighs 690kg, the aux. hook weighs 160kg.
2. Radius shown in the chart is the actual radius when loading.
3. The load capacity in the chart is the maximum weight when this crane is supported with the firm ground and stays in level.
4. Choose rated load capacity of the longer boom and radius when the actual boom length and radius are between two values in the charts.
5. The machine can be used only when the wind power is less than grade 6.

1. 性能表中额定起重量包括起重钩 (主钩重 690kg, 副钩重 160kg) 和吊具的重量。
2. 性能表中工作幅度是指吊载后的实际幅度。
3. 性能表中给定数值是在平整坚固的地面上, 整机调平状态下起重机的最大起重量。
4. 如实际臂长和幅度介于两个数值之间时, 取较长的臂长及较大的幅度所决定的额定起重量进行起重作业。
5. 起重作业风力等级需低于 6 级。

Operating Range - Fixed Jib

起升高度曲线 - 副臂

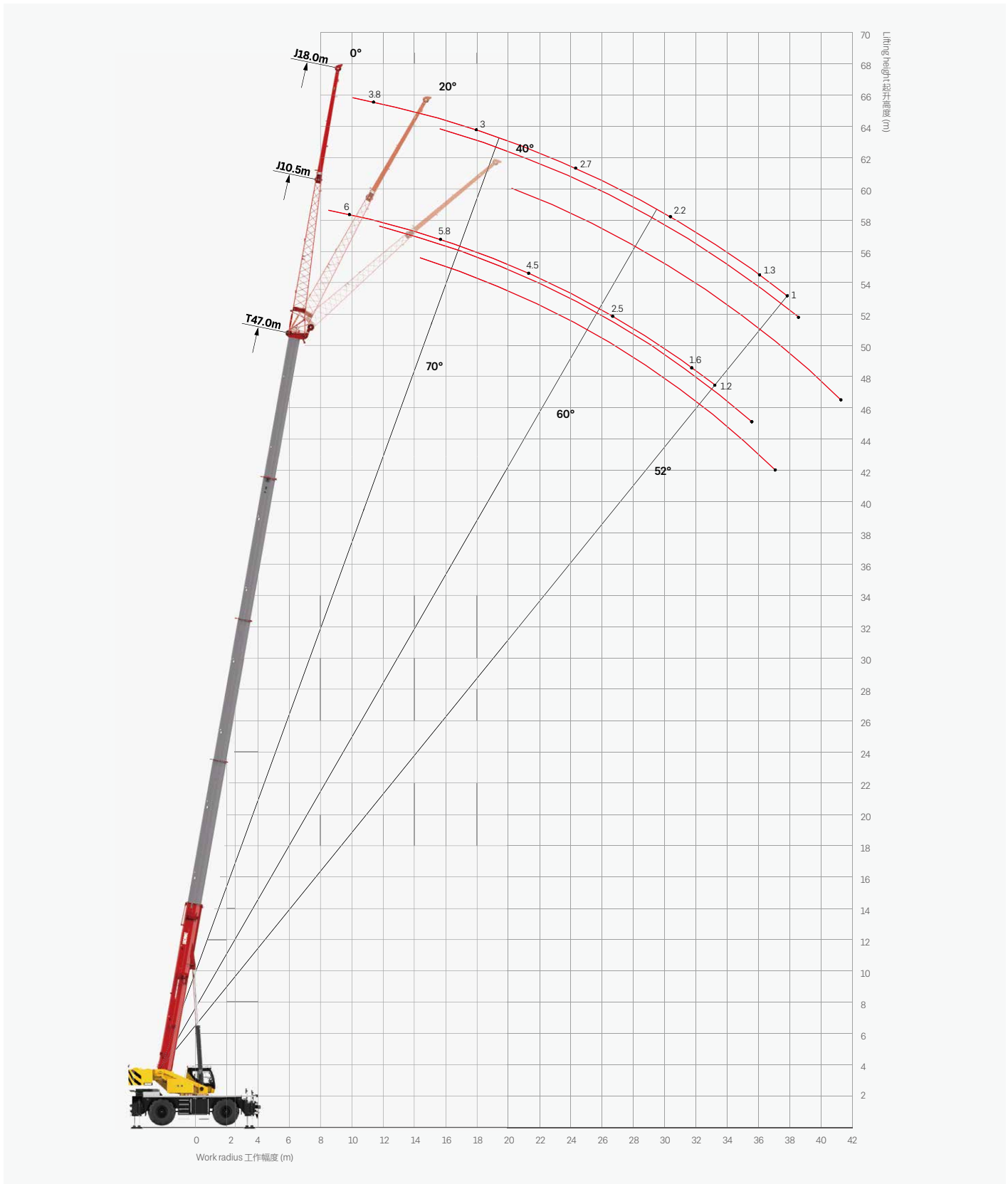

Load Chart - Fixed Jib

性能表 - 副臂

Unit: kg

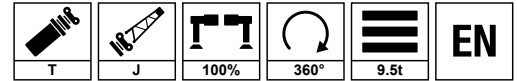

	47.0 + 10.5						47.0 + 18.0						
	0°		20°		40°		0°		20°		40°		
80.0	7.7	6000	11.2	5000	14.0	4400	9.0	3800	14.9	2600	19.7	2100	80.0
78.0	9.7	6000	13.1	4800	15.8	4300	11.3	3800	17.1	2600	21.7	2100	78.0
76.0	11.7	6000	15.0	4600	17.6	4200	13.5	3500	19.2	2500	23.7	2100	76.0
74.0	13.6	6000	16.9	4300	19.4	4100	15.7	3200	21.3	2400	25.6	2000	74.0
72.0	15.5	5800	18.7	4100	21.2	3900	17.8	3000	23.4	2300	27.5	1900	72.0
70.0	17.4	5500	20.6	3800	22.9	3700	20.0	2900	25.4	2200	29.4	1800	70.0
68.0	19.3	5000	22.4	3500	24.6	3400	22.1	2800	27.4	2100	31.2	1700	68.0
66.0	21.1	4500	24.2	3100	26.3	2800	24.2	2700	29.4	2000	33.0	1600	66.0
64.0	23.0	3700	25.9	2700	27.9	2700	26.2	2600	31.3	1900	34.8	1500	64.0
62.0	24.7	3100	27.6	2500	29.6	2500	28.3	2400	33.2	1700	36.5	1400	62.0
60.0	26.5	2500	29.3	2300	31.1	2100	30.3	2200	35.0	1600	38.2	1300	60.0
58.0	28.2	2100	30.9	1800	32.6	1600	32.2	1900	36.8	1400	39.8	1200	58.0
56.0	29.9	1800	32.5	1300	34.1	1200	34.1	1600	38.6	1100	41.3	1100	56.0
54.0	31.5	1600	34.1	1200	35.6	1100	36.0	1300					54.0
52.0	33.2	1200	35.6	1100	37.0	1000	37.8	1000					52.0
	1		1		1		1		1		1		
	2#	100%	100%	100%	100%	100%	100%	100%	100%	100%	100%	100%	2#
	3#	100%	100%	100%	100%	100%	100%	100%	100%	100%	100%	100%	3#
	4#	100%	100%	100%	100%	100%	100%	100%	100%	100%	100%	100%	4#
	5#	100%	100%	100%	100%	100%	100%	100%	100%	100%	100%	100%	5#
	50		50		50		50		54		54		
	700		600		500		500		600		600		

Load Chart - Telescopic Boom, On Tires Stationary, Load Over Front

性能表 - 轮胎静止吊载 (正前方)

Unit: kg



	12.2	16.6	20.9	25.3	29.6	
4.0	22400	22000	21000			4.0
4.5	20300	20900	20000	19500		4.5
5.0	18300	19000	19000	18000	17000	5.0
5.5	16900	17000	18000	16000	16000	5.5
6.0	14800	15000	16500	15000	15000	6.0
6.5	12800	13500	14500	14000	14000	6.5
7.0	11200	12300	13000	13000	13000	7.0
8.0	8600	9500	10300	10500	11000	8.0
9.0	6700	7800	8500	8900	9200	9.0
10.0		6200	7000	7300	7700	10.0
11.0		5200	5800	6200	6500	11.0
12.0		4200	4900	5200	5500	12.0
14.0			3400	3800	4000	14.0
16.0			2300	2700	3000	16.0
18.0			1500	1800	2100	18.0
20.0					1500	20.0
	4	4	4	4	4	
	2#	0%	0%	0%	0%	2#
	3#	0%	17%	33%	50%	3#
	4#	0%	17%	33%	50%	4#
	5#	0%	17%	33%	50%	5#
	0	0	0	36	41	
	4000	2500	800	800	800	
	80	80	80	80	80	

Load Chart - Telescopic Boom, Pick & Carry, Load Over Front

性能表 - 主臂帶載行駛 (正前方)

Unit: kg



	12.2	16.6	20.9	25.3	29.6		
4.0	14300	14000	14000			4.0	
4.5	12900	13500	13600	13800		4.5	
5.0	11600	12200	12500	12800	13000	5.0	
5.5	10500	11100	11500	11700	11900	5.5	
6.0	9600	10200	10600	10800	11000	6.0	
6.5	8700	9300	9700	10000	10100	6.5	
7.0	7900	8600	8800	9200	9400	7.0	
8.0	6600	7300	7600	7800	8100	8.0	
9.0	5500	6200	6600	6800	7100	9.0	
10.0		5400	5800	6000	6200	10.0	
11.0		4500	5000	5200	5500	11.0	
12.0		3700	4200	4500	4600	12.0	
14.0			3000	3300	3500	14.0	
16.0			2000	2300	2500	16.0	
18.0					1600	18.0	
	4	4	4	4	4		
	2#	0%	0%	0%	0%	2#	
	3#	0%	17%	33%	50%	67%	3#
	4#	0%	17%	33%	50%	67%	4#
	5#	0%	17%	33%	50%	67%	5#
	0	0	30	44	47		
	3000	1500	800	800	800		
	80	80	80	80	80		

Load Chart - Telescopic Boom, On Tires Stationary, 360° Slewing

性能表 - 轮胎静止吊载(360°)



Unit: kg

	12.2	16.6	20.9	25.3	29.6	
4.0	15500					4.0
4.5	13000					4.5
5.0	10500	10700				5.0
5.5	9000	9100				5.5
6.0	7600	7900	8500			6.0
6.5	6500	6900	7500	8000		6.5
7.0	5500	6000	6500	7000	7200	7.0
8.0	4100	4600	5000	5500	5800	8.0
9.0	3000	3600	4000	4500	4800	9.0
10.0		2800	3100	3500	3800	10.0
11.0		2100	2400	2800	3000	11.0
12.0		1500	1800	2200	2300	12.0
	4	4	4	4	4	
	2#	0%	0%	0%	0%	2#
	3#	0%	17%	33%	50%	3#
	4#	0%	17%	33%	50%	4#
	5#	0%	17%	33%	50%	5#
	0	32	48	56	61	
	1000	800	800	800	800	
	65	69	71	73	75	

Remark

1. Capacities are applicable at 525kPa cold tire inflation pressure.
2. Capacities are applicable only with machine on firm level surface.
3. On tire lifting with the jib mounted is not permitted.
4. Axle lockouts must be applied when lifting on tires.
5. Parking brake must be applied when lifting on tires stationary.
6. Driving speed shall be ~4km/h at pick & carry mode.

1. 冷态轮胎气压需保持 525kPa。
2. 起重机需在平整坚固的地面上作业。
3. 轮胎吊载工况不允许使用副臂吊载。
4. 轮胎吊载工况中，车桥悬挂需锁定。
5. 轮胎静止吊载工况中，需使用驻车制动。
6. 带载行驶工况中，直线行驶速度需小于等于 4km/h。



SANY GROUP CRANE BU

SANY Mobile Crane Industrial Park, No.168 Jinzhou Avenue, Jinzhou Development Zone, Changsha City,
Hunan Province, P.R. China Zip 410600
Consulting sanycrane@sanygroup.com (Crane BU) / crd@sany.com.cn (IHQ)
After-sales Service 0086-400 6098 318

Reminder:

Any change in the technical parameters and configuration due to product modification or upgrade may occur without prior notice.
The machine in the picture may include additional equipment. This brochure is for reference only, and goods in kind shall prevail.
Copyright at SANY. No part of this brochure may be copied or used for any purpose without written approval from SANY.

© Edited in November 2022

三一集团起重事业部

中国湖南长沙金洲开发区金洲大道 168 号 三一汽车起重机产业园 邮编: 410600
咨询: sanycrane@sanygroup.com (起重事业部) / crd@sany.com.cn (国际总部)
海外售后服务: 0086-400 6098 318

温馨提示:

由于技术不断更新, 技术参数及配置如有更改, 恕不另行通知。图中机器可能包括附加设备, 本画册仅供参考, 以实物为准。
版权为三一所有, 未经三一书面许可, 本画册任何内容不得被复制用于任何目的。

© 2022 年 11 月版

