



# SCI850A

## SANY Crawler Crane

### 85 Tons Lifting Capacity

Quality Changes the World



**Max. lifting moment: 358t·m**  
**Largest boom length: 57m**  
**Max. boom+jib combination: 48m+18m**

The parameters, pictures and standard/optional equipment are only for reference in this brochure, the actual machine is based on the effective price list and contract.

■ [www.sanyglobal.com](http://www.sanyglobal.com)

V1.1



## Crawler Crane Series SCI850A

P03

Main  
Characteristics

- Product Specifications
- Safety Device

P09

Technical  
Parameters

- Major Performance & Specifications
- Outline Dimension
- Transport Dimension
- Transport Plan

P17

Boom  
Combination

- H Configuration
- FJ Configuration



**SCI850A**  
**SANY CRAWLER CRANE**  
**85 TONS LIFTING CAPACITY**

QUALITY CHANGES THE WORLD

## Main Characteristics

- Page 04 Product Specifications
- Page 07 Safety Device



## Product Specification



### Engine

- ISUZU 6HK1XKSC Diesel Engine.
- Type: 6-cylinder in-line, direct injection, water-cooled, intercooler. Compliant with European Off-highway Tier III emission standard, and Chinese Off-highway Tier III emission standard.
- Displacement: 7.79L.
- Rated power 212 kW/2000rpm.
- Operation power: 200kW/1800rpm.
- Max. output torque 1080N·m/1500rpm.
- Starter device: 24V-5.0kW.
- Battery: two 12V large battery in serial connection.
- Fuel tank: 400L.

### Electrical Control System

- SYIC-2 integrated control system independently developed by SANY is adopted to ensure high system integration, accurate operation, and reliable quality. The control system mainly includes power system, engine system, master control system, load moment limiter system, auxiliary system, and safety monitoring system.
- The controller, monitor, and the engine communicates through CAN Bus.
- Monitor: the working parameters and status are shown on the monitor, such as the engine speed, fuel volume, engine oil pressure, servo pressure, engine working hours, lifting conditions and boom angle.
- The Skyeeye Monitoring System and Remote Control of machine traveling on/off the trailer is offered as optional.

### Hydraulic System

- Main pump: adopt large piston pump with open displacement to provide oil for the machine actuator;
- Gear pump: dual gear pumps are used for swing, radiator and control circuit.
- Control: the main pump adopt the control of electrical proportionate positive flow; winch motor is piston motor of variable displacement. The operation components are two hydraulic control handles, and one dual travel pedal control valve to control each actuator in proportionate way.
- System max. pressure: Main load hoist, aux. load hoist, boom hoist winch and travel system: 35MPa.
- Swing system: 24MPa;
- Control system: 5MPa;
- Hydraulic oil tank capacity: 305L.

### Swing Mechanism

- Swing brake adopts wet, spring loaded, normally-closed brake, and braking through spring force;
- Swing system, equipped with integrated swing buffer valve, has free slipping function. It is featured in steady starting and control, and excellent inching function. Unique swing buffer design and steadier brake;
- Internal-gear swing drive can swing the upperworks by 360°.
- Swing lock: Swing lock is designed. When the operation is over or the machine is in transport, the upperworks can be locked tightly.
- Swing bearing: single row ball bearing.
- Swing speed: 0-2.4rpm.



## Product Specification

### Main Load and Aux. Load Hoist Mechanism

- Main and aux. hoist winches are driven separately by motor via gearbox. Operating winch handle can control the winch to rotate to two directions, which are lifting and lowering of hook. Excellent inching function is equipped on the machine.
- Drums with fold-line grooves can ensure the wire rope reeved in order in multilayers.
- Free fall for main and aux. load hoist is offered as optional.

Main, aux. load hoist	Rope speed of main/aux. load hoist winch	0~135m/min
	Wire rope diameter	Φ22mm
	Wire rope length of main/aux. load hoist	240m\150m
	Rated single line pull	8t

### Boom Hoist Mechanism

- Boom hoist winches are driven separately by motor via gearbox. Operating winch handle can control the winch to rotate to two directions, which are lifting and lowering of boom.
- Drums with fold-line grooves can ensure the wire rope reeved in order in multilayers.

Boom hoist mechanism	Rope speed of boom hoist winch	0~55m/min
	Wire rope diameter	Φ16mm
	Wire rope length of boom hoist	148m

### Cab and Control

- The upgraded cab is designed with interior and control consoles more softened and consistent. The hatchback glass at front and sliding window ventilate the cab and easy communication. There are low and high-beam lights, back-view mirror, heater and A/C, radio and other functions. The layout of seat, handles, control buttons are designed with ergonomic principles to make operation more comfortable;
- Cab layout: Large integrated touch screen and discrete monitoring display; man-machine interaction interface are more perfect;
- Armrest box: On left and right armrest box are control handles, electrical switches, emergent stop and ignition switch. The armrest box can be adjusted along with the seat;
- Seat: multi-way and multi-level floating adjustable seat with unload switch;
- A/C: cool and heat air; optimized air channels and vents;
- The display with back-video can monitor conditions behind the counterweight and surrounding the machine at real time.

### Counterweight

- Counterweight tray and blocks are piled up for easier assembly and transport.
- Rear counterweight: total 27.6t.
- Rear counterweight: tray 8.2t×1, left counterweight block 3t×2, right counterweight block 3t×2, left counterweight block 3.7t×1, and right counterweight block 3.7t×1.
- Carbody counterweight: 7.8t in total, 3.9t×2 at the front and rear of carbody.

## Product Specification



### Upperworks

- Weldment frame of high-strength steel, no torsion; reasonable arrangement of the parts for easy maintenance.

### Lowerworks

- Independent travel driving units are adopted for each side of the crawler, to realize straight walking and turning driven by travel motor through gearbox and drive wheel.
- Lower outrigger cylinders are optional.

### Crawler Extension and Retraction

- The crawlers can extend and retract via cylinders. During Work Mode, the crawlers must be extended, and retracted during transport with crawlers on when no load limit required.

### Crawler Tensioning

- The jack is used to push the guide wheel and insert the shim to adjust crawler tension.

### Track Pad

- High-strength alloy cast steel track pad can prolong the service life.
- They are 800mm wide, and the total is 65pcs×2.

### Operating Equipment

- All chords are high-strength steel tubes, and the boom/jib top sheaves are made of high-strength anti-wearing Nylon material protecting wire rope. The hooks are installed with milled welded steel sheave.

### Boom

- Lattice structure. The chord adopts high-strength structural tube and each section is connected through pins.
- Basic boom: 6m boom top + 6m boom base;
- Boom insert: 3m×1, 6m×1, 9m×4;
- Boom length: 12m~57m.

### Fixed Jib

- Lattice structure. The chord adopts high-strength structural tube and each section is connected through pins.
- Basic boom: 4.5m boom top + 4.5m boom base;
- Boom insert: 4.5m×2;
- Boom length: 9m~18m;
- Longest boom + jib: 48m boom +18m jib.

### Extension Jib

- The extension jib is a welded structure connected to the boom tip by pins, used for auxiliary hook.
- Extension jib length: 1.1m.

### Hook Block

- 80t hook block, 5 sheaves;
- 45t hook block, 3 sheaves;
- 15t hook block, 1 sheave;
- 9t ball hook.

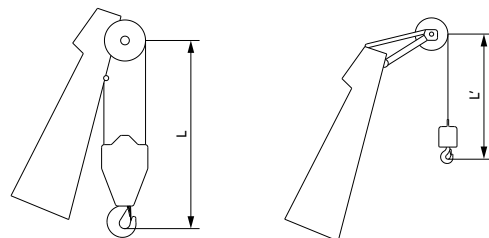



## Safety Device

### Assembly Mode/Work Mode Switch

- In Assembly Mode, some safety protection devices are off work to facilitate crane assembly;
- In Work Mode, all safety devices activate to protect the operation.

### Emergent Stop

- In emergent situation, this button is pressed down to cut off the power supply of whole machine and all actions stop.

### Load Moment Indicator (LMI)

- It is an independent computerized safety control system. LML can automatically detect the load weight, work radius and boom angle, and present on the display the rated load, actual load, work radius and boom angle. In normal operation, the LML can make a judgment and cut off automatically if the crane moves towards dangerous direction. It can also perform as a black box to record the lifting information.
- Composition: display, angle sensor, force sensor.

### Over-hoist Protection of the Main/ Auxiliary Hooks

- Over-hoist protection device comprises of limit switch and weight on boom top, which prevents the hook lift up too much. When the hook lifts up to the limit height, the limit switch activates, buzzer on the left control panel sends alarm, and failure indicator light starts to flash, the hook hoisting action is cut off automatically.

### Over-release Protection Device of the Main/Auxiliary Winch

- It is comprised of activator in the drum and proximity switch to prevent over release of wire rope. When the rope is paid out close to the last three wraps, the limit switch acts, and the system sends alarm through buzzer and show the alarm on the instrument panel, automatically cutting off the winch action.

### Function Lock

- If the function lock level is not in work position, all the other handles won't work, which prevents any mis-operation caused by accidental collision.

### Boom Hoist Drum Lock

- Boom hoist drum lock is designed to lock the winch action when it is not used, so as to prevent mis-operation. The boom hoist winch pawl can open and close along with the lever. When the lever comes back to neutral, the pawl will lock the drum automatically to make sure the boom stays safe while not working.

### Swing Lock

- Swing Lock can lock the machine at four positions, front and back, left and right.

### Boom Limit Device

- When the boom elevation angle reaches the max. angle, the buzzer sounds and boom action cut off. This protection is two-stage control ensured by both LML system and travel switch.

### Back-stop Device

- Its major components are nesting tubes and spring, in order to buffer the boom backlash and prevent further tipping back.

### Boom Angle Indicator

- Pendulum angle indicator is fixed on the side of boom base close to the cab, so as to provide convenience to the operator.

### Hook Latch

- The lifting hook is installed with a baffle plate to prevent wire rope from falling off.

## Safety Device



### Tri-color Load Indicator

- The load indication light has three colors, green, yellow and red, and the real time load status is presented on the display. When the actual load is smaller than 90% of rated load, the green light is on; when the actual load is larger than 90% and smaller than 100%, the yellow light is on, the alarm light flashes and sends out intermittent sirens; when the actual load reaches 100% of rated load, the red light on, the alarm light flashes and sends out continuous sirens. When the actual load reaches 102% of the rated load, the system will automatically cut off the crane's dangerous operation.

### Warning Light

- Warning light will keep flashing once the machine is powered on, so as to warn the people around the machine.

### Swing Indicator Light

- The swing indicator light flashes during traveling or swing.

### Illumination Light

- The machine is equipped with, short-beam light in front of machine, front angle adjustable far-beam, lamps in operator's cab, lighting devices for night operation, so as to increase the visibility during work.

### Rearview Mirror

- It is installed on the left of the operator's cab for monitoring the rear part of the machine.

### Pharos

- Pharos is mounted on the top of boom/jib to indicating the height.

### Anemometer

- It is mounted on the top of boom/jib, and the real-time wind speed is displayed on the monitor in the cab.

### Electronic Level Gauge

- It displays the tipping angle of crane on the monitor in real time. The automatic warning will show up once it is over the set value.

### Function Lock Lever

- If the operator leaves the seat, all control handles will be locked immediately to prevent any mis-operation due to accidental collision.

### Engine Power Limit Load Adjustment and Stalling Protection

- The controller monitors the engine power to prevent engine getting stuck and stalling.

### Engine Status Monitoring

- The engine status will be presented, such as engine coolant temperature, fuel volume, total work hours, engine oil pressure, engine speed, battery charging, voltage.

### GPS Monitoring System

- Standard remote monitor: GPS positioning, GPRS data transfer, working status and statistics, operation data monitor and analysis, and remote diagnosis of failure.





**SCI850A**  
**SANY CRAWLER CRANE**  
**85 TONS LIFTING CAPACITY**

QUALITY CHANGES THE WORLD

## Technical Parameters

- Page 10 Major Performance & Specifications
- Page 11 Outline Dimension
- Page 12 Transport Dimension
- Page 17 Transport Plan



## Major Performance & Specifications

Major Performance & Specifications of SCI850A			
Performance Indicators		Unit	Parameter
Boom Configuration	Max. rated lifting capacity	t	85
	Max. lifting moment	t m	358
	Boom length	m	12~57
	Boom hoist angle	°	30~80
FJ	Jib length	m	9~18
	Longest boom + longest jib	m	48+18
Speed	Rope speed of main/aux. winch	m/min	0~135
	Rope speed of boom hoist winch	m/min	0~55
	Swing speed	rpm	0~2.4
	Travel speed	km/h	0~1.3
Wire rope	Main hoist wire rope: diameter × length	φ mm × m	22×240
	Aux. hoist wire rope: diameter × length	φ mm × m	22×150
	Single line pull of main/aux. load hoist wire rope	t	8
Engine	Model/Displacement	\L	ISUZU 6HK1V7.79
	Rated power/revolution speed	kW/ rpm	212/2000
Transport	Weight of basic boom	t	75.5
	Rear counterweight	t	27.6
	Transport weight of basic machine (with crawler frame and boom base)	t	37.5
	Transport weight of basic machine (without crawler frame and boom base)	t	20.6
	Machine transport dimension (with crawlers and boom base) L×W×H	mm	12500×3450×3460
	Machine transport dimension (without crawlers and boom base)L×W×H	mm	7800×3000×3100
Other specifications	Average ground pressure (basic boom)	MPa	0.082
	Gradeability	%	30

## Outline Dimension

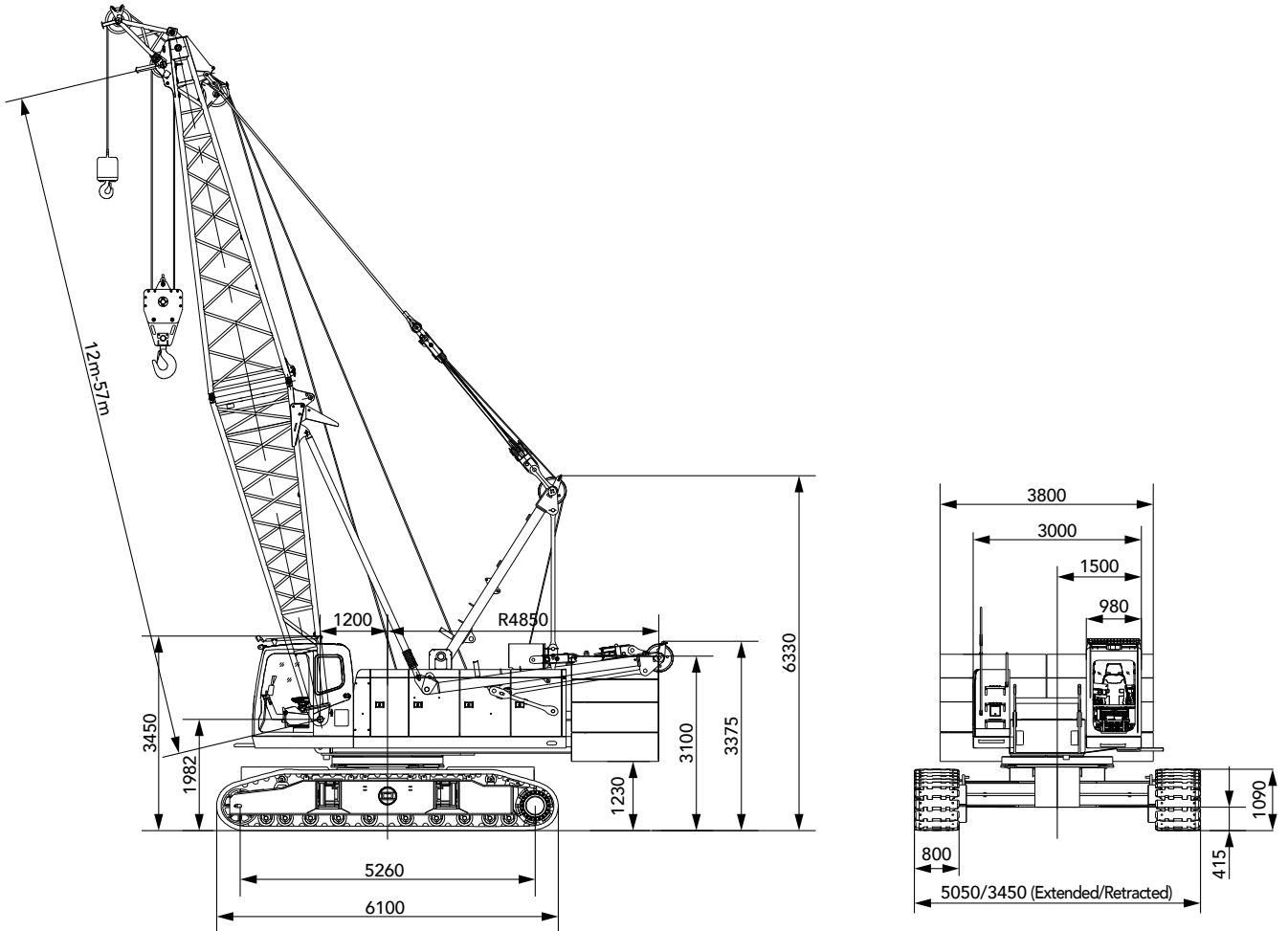

## Transport Dimension

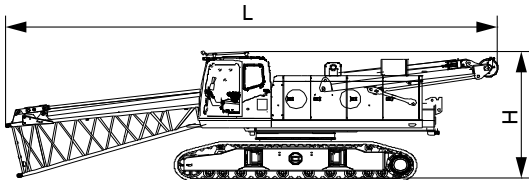

### Basic Machine 1 (with boom base, crawlers) ×1

Length(L)	12.50m
Width(W)	3.45m
Height(H)	3.46m
Weight	37.5t

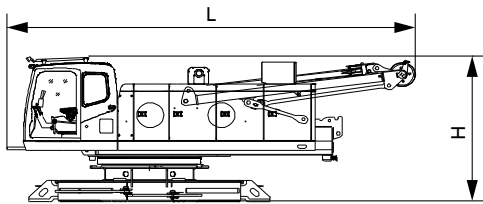

### Basic Machine 3 (without boom base, crawlers) ×1

Length(L)	7.80m
Width(W)	3.00m
Height(H)	3.10m
Weight	20.6t

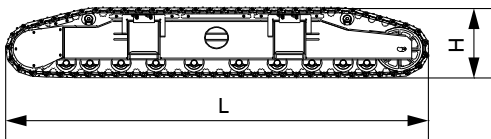

### Crawlers ×2

Length(L)	6.10m
Width(W)	1.10m
Height(H)	1.10m
Weight	7.83t

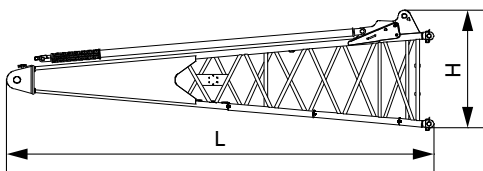

### Boom Base ×1

Length(L)	6.22m
Width(W)	1.51m
Height(H)	1.87m
Weight	1.24t

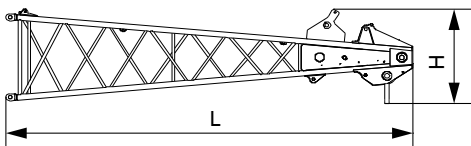

### Boom Top ×1

Length(L)	6.48m
Width(W)	1.51m
Height(H)	1.65m
Weight	1.00t

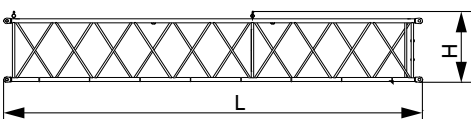

### 9m Boom Insert ×4

Length(L)	9.13m
Width(W)	1.51m
Height(H)	1.55m
Weight	0.9t

## Transport Dimension

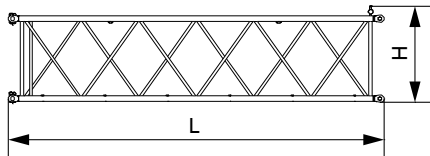

### 6m Boom Insert ×1

Length(L)	6.14m
Width(W)	1.51m
Height(H)	1.55m
Weight	0.62t

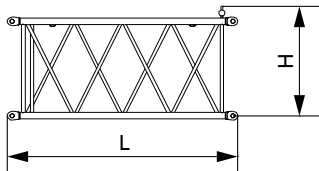

### 3m Boom Insert ×1

Length(L)	3.14m
Width(W)	1.51m
Height(H)	1.55m
Weight	0.4t

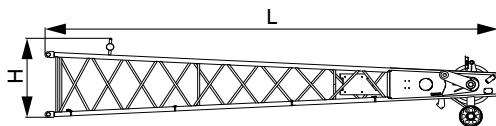

### Fixed Jib Top ×1

Length(L)	4.87m
Width(W)	0.87m
Height(H)	0.92m
Weight	0.31t

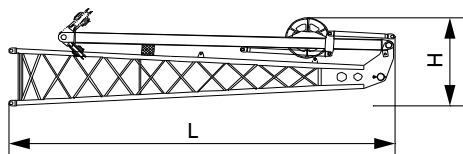

### Fixed Jib Base and Strut ×1

Length(L)	4.75m
Width(W)	0.87m
Height(H)	1.18m
Weight	0.75t

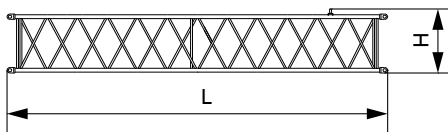

### 4.5m Fixed Jib ×2

Length(L)	4.57m
Width(W)	0.87m
Height(H)	0.83m
Weight	0.24t

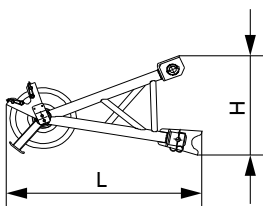

### Extension Jib ×1

Length(L)	1.38m
Width(W)	0.96m
Height(H)	0.77m
Weight	0.14t

## Transport Dimension

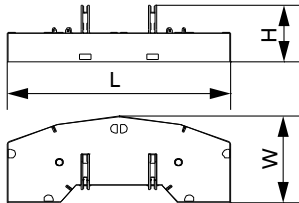

### Counterweight Tray

×1

Length(L)	3.80m
Width(W)	1.55m
Height(H)	1.05m
Weight	8.2t

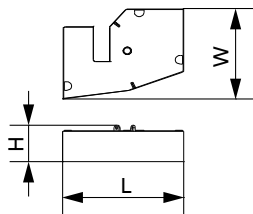

### Right Counterweight Block I

×1

Length(L)	1.90m
Width(W)	1.56m
Height(H)	0.63m
Weight	3.7t

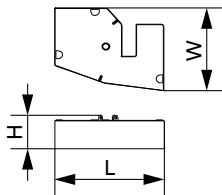

### Left Counterweight Block I

×1

Length(L)	1.90m
Width(W)	1.56m
Height(H)	0.63m
Weight	3.7t

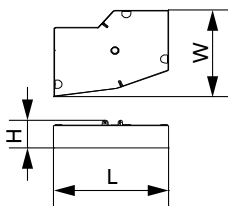

### Right Counterweight Block II

×1

Length(L)	1.90m
Width(W)	1.56m
Height(H)	0.50m
Weight	3.0t

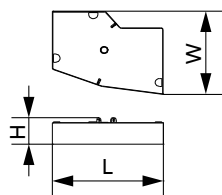

### Left Counterweight Block II

×1

Length(L)	1.90m
Width(W)	1.56m
Height(H)	0.50m
Weight	3.0t

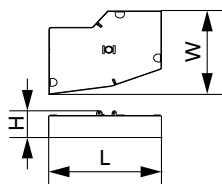

### Right Counterweight Block III

×1

Length(L)	1.90m
Width(W)	1.56m
Height(H)	0.50m
Weight	3.0t

## Transport Dimension

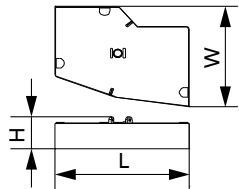

### Left Counterweight Block III ×1

Length(L)	1.90m
Width(W)	1.56m
Height(H)	0.50m
Weight	3.0t

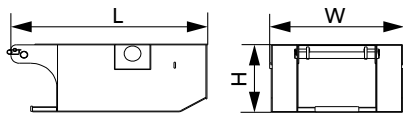

### Carbody Counterweight ×2

Length(L)	1.90m
Width(W)	1.30m
Height(H)	0.72m
Weight	3.9t

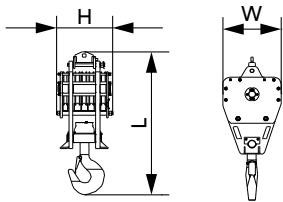

### 80t Hook ×1

Length(L)	1.87m
Width(W)	0.69m
Height(H)	0.66m
Weight	1.03t

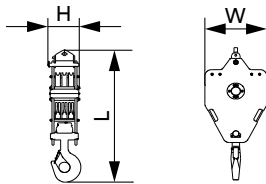

### 45t Hook ×1

Length(L)	1.52m
Width(W)	0.69m
Height(H)	0.37m
Weight	0.48t

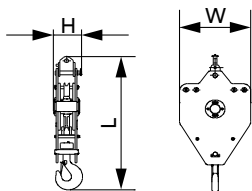

### 15t Hook ×1

Length(L)	1.34m
Width(W)	0.60m
Height(H)	0.34m
Weight	0.28t

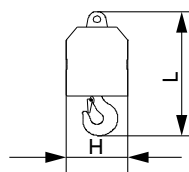

### 9t Hook ×1

Length(L)	0.75m
Width(W)	0.30m
Height(H)	0.30m
Weight	0.18t

Note:

- The transport dimensions of each part in the table are schematic, not proportional to the real parts. The dimensions are designed value without package considered.
- The Weight is designed value that the actual manufactured part may deviate a little.

## Transport Plan

Trailer 1	
Part(s)	<ul style="list-style-type: none"> <li>Basic Machine</li> </ul>
Weight	<ul style="list-style-type: none"> <li>37.5t</li> </ul>

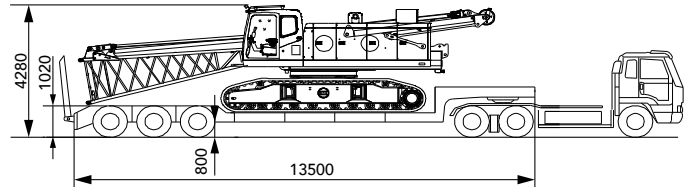

Trailer 2	
Part(s)	<ul style="list-style-type: none"> <li>9m Boom insert×2</li> <li>Boom top×1</li> <li>6m boom insert×1</li> <li>Extension jib×1</li> <li>Carbody counterweight×2</li> <li>4.5m fixed jib insert×2</li> <li>Left counterweight 2×1</li> <li>Right counterweight 2×1</li> <li>80t hook×1</li> <li>45t hook×1</li> <li>15t hook×1</li> <li>9t ball hook×1</li> </ul>
Weight	<ul style="list-style-type: none"> <li>19.8t</li> </ul>

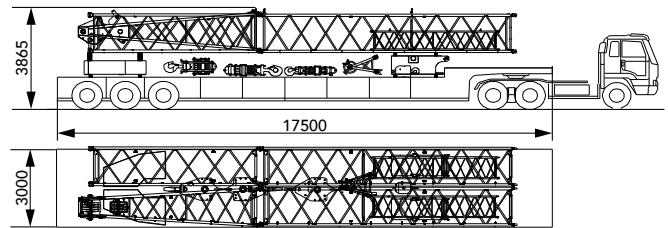

Trailer 3	
Part(s)	<ul style="list-style-type: none"> <li>9m boom insert×2</li> <li>3m boom insert×1</li> <li>Left counterweight 1×1</li> <li>Right counterweight 1×1</li> <li>Counterweight tray×1</li> <li>Left counterweight 3×1</li> <li>Right counterweight 3×1</li> <li>Fixed jib base×1</li> <li>Fixed jib top×1</li> </ul>
Weight	<ul style="list-style-type: none"> <li>25t</li> </ul>

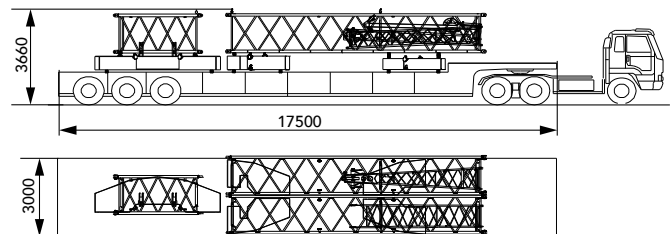





**SCI850A**  
**SANY CRAWLER CRANE**  
**80 TONS LIFTING CAPACITY**

QUALITY CHANGES THE WORLD

## Boom Combination

- Page 19 H Configuration
- Page 23 FJ Configuration

> 17

# Applications

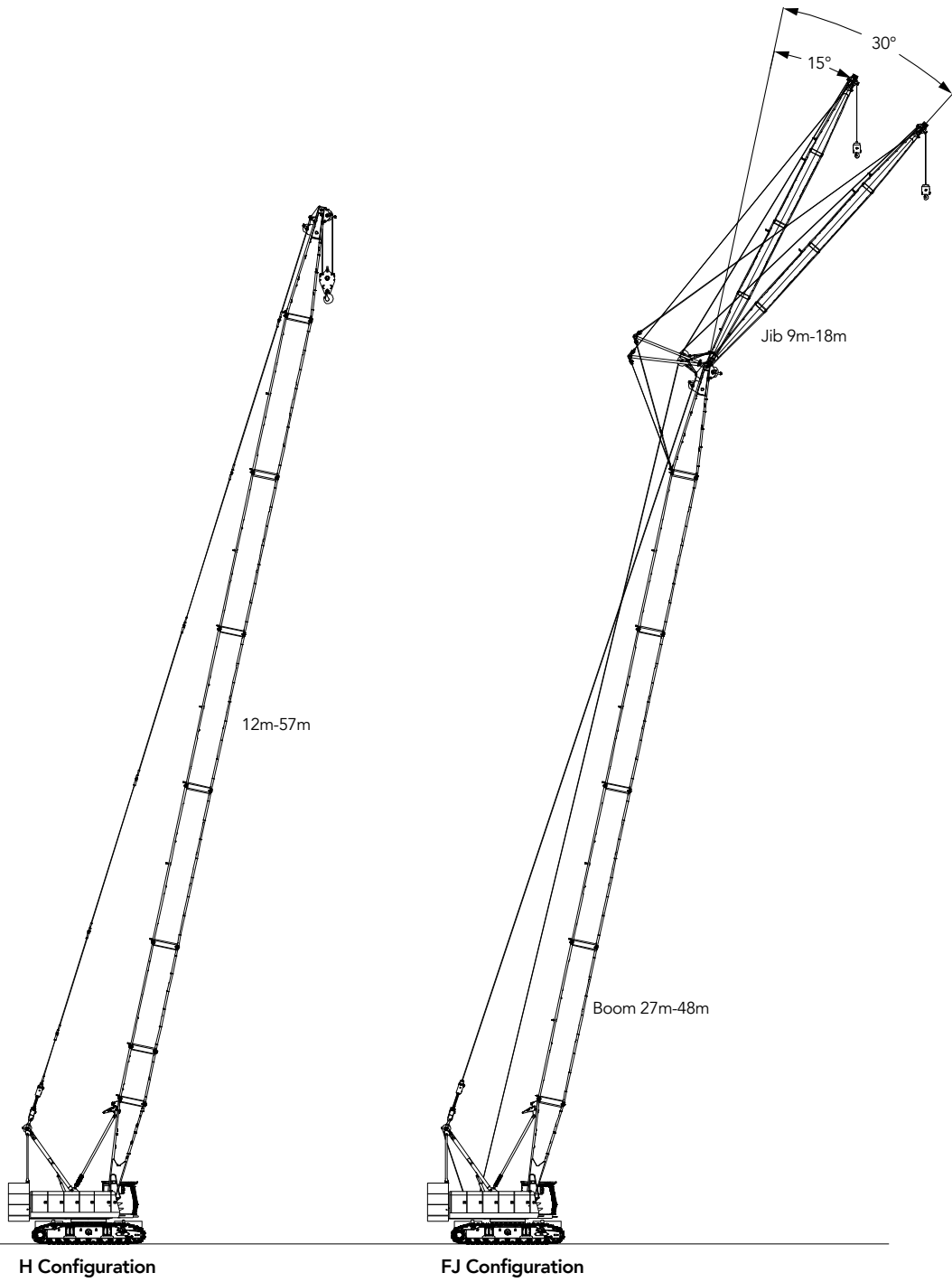

## Boom Combination in H

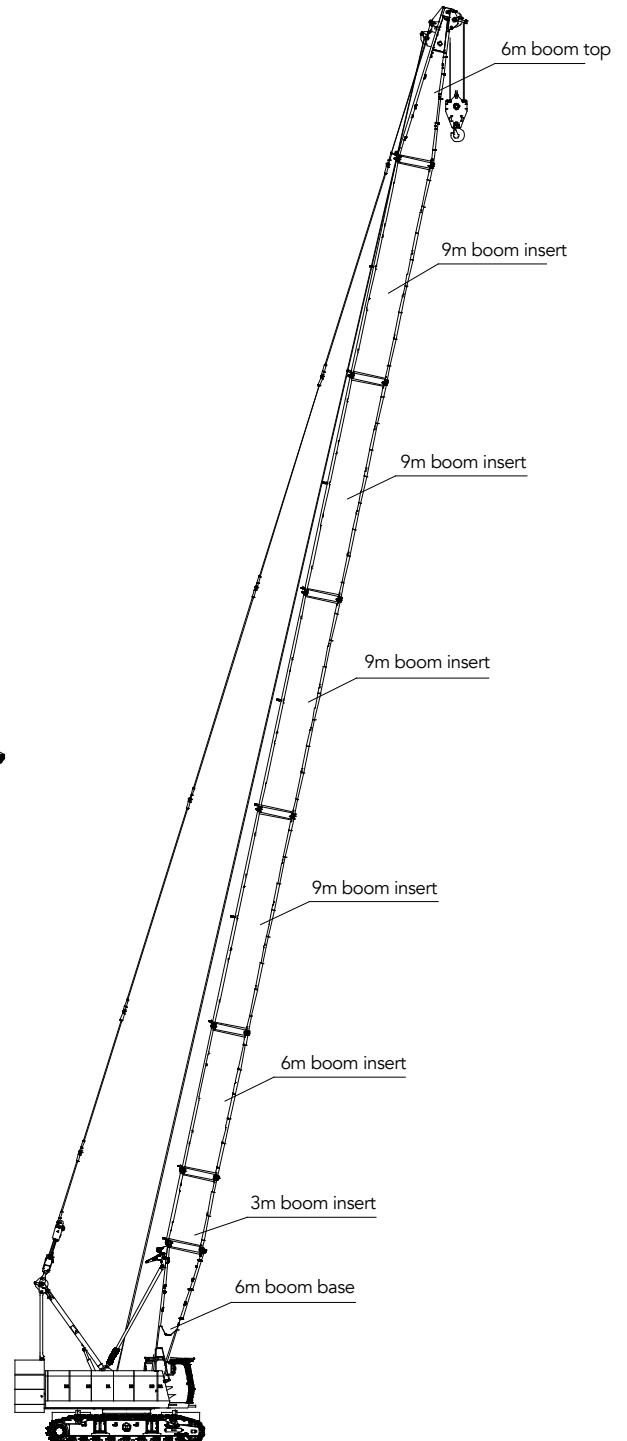
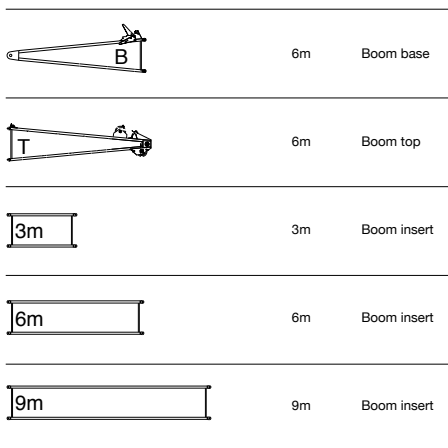
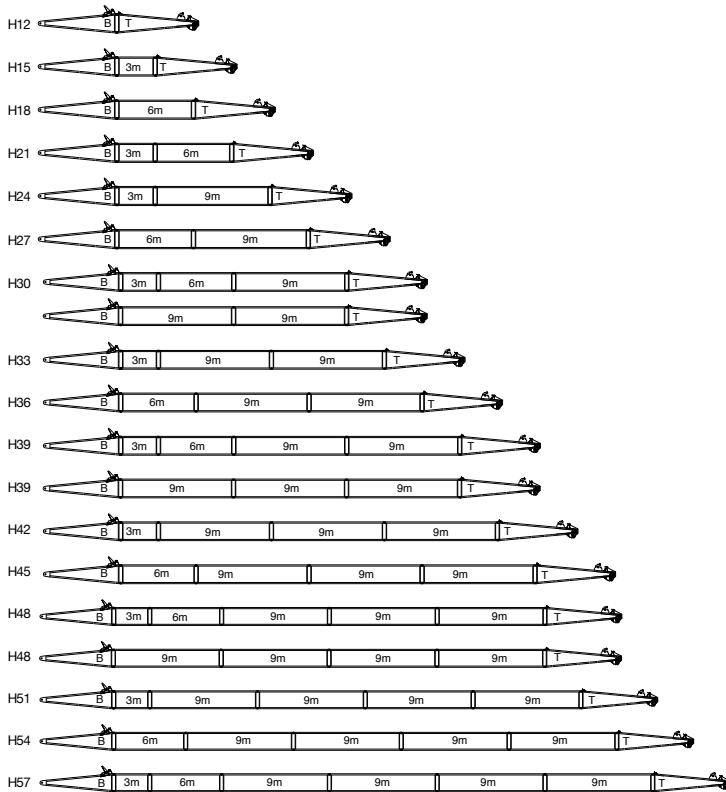

# Working Radius in H Configuration

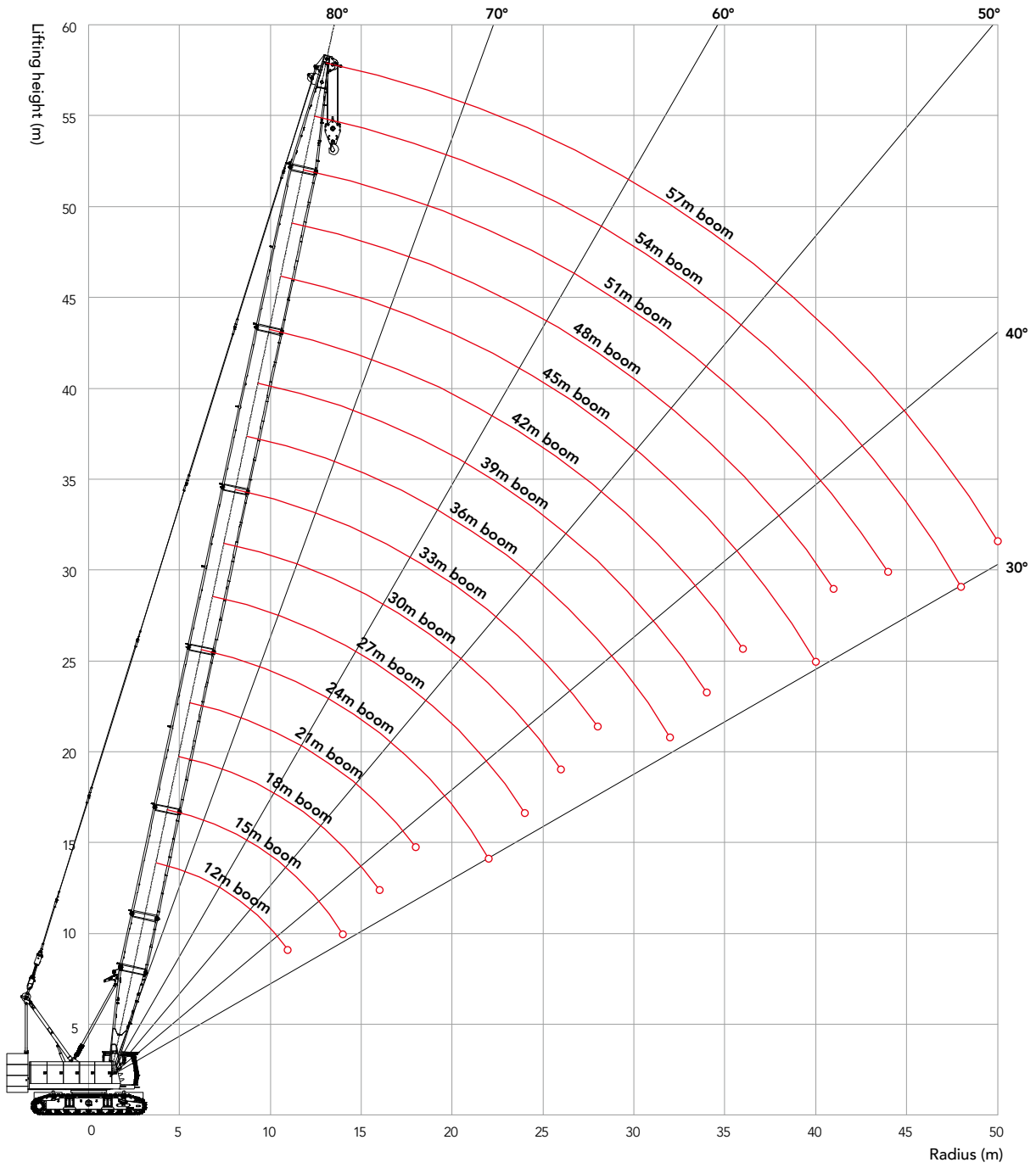

Unit: t

## Load Chart of H Configuration

SCI850A Crawler Crane-H Configuration 1/2										
Boom Length 12m~57m, Rear counterweight 27.6t, Carbody counterweight 7.8t										
R(m) \ BL(m)	12	15	18	21	24	27	30	33	BL(m) \ R(m)	
4	85									4
5	71.6	70	68							5
6	55.3	54.8	54.2	52.8	51.8					6
7	43.9	43.9	43.9	43.8	43.8	43	42			7
8	36.2	36.2	36.1	36.1	36	36	35.8	35.1		8
9	30.8	30.7	30.7	30.6	30.5	30.5	30.4	30.3		9
10	26.7	26.7	26.6	26.5	26.5	26.4	26.3	26.2		10
11	23.6	23.5	23.5	23.4	23.3	23.2	23.2	23.1		11
12		21	21	20.9	20.8	20.7	20.6	20.5		12
14		17.3	17.2	17.1	17	17	16.9	16.8		14
16			14.5	14.5	14.4	14.3	14.2	14.1		16
18				12.5	12.4	12.3	12.2	12.1		18
20					10.8	10.7	10.6	10.5		20
22					9.6	9.5	9.4	9.3		22
24						8.5	8.4	8.3		24
26							7.5	7.4		26
28								6.7		28

Note: Gray shaded values are determined by strength, and others by stability.

## Load Chart of H Configuration

SCI850A Crawler Crane-H Configuration 2/2											
Boom Length 12m~57m, Rear counterweight 27.6t, Carbody counterweight 7.8t											
R(m)	BL(m)	36	39	42	45	48	51	54	57	BL(m)	R(m)
8		34.4									8
9		30	29.5	28.9							9
10		26.2	26.1	25.6	25.1	24.7					10
11		23	23	22.8	22.5	22.2	21.7				11
12		20.5	20.4	20.3	20.2	20	19.6	18	16		12
14		16.7	16.6	16.5	16.4	16.4	16.2	16	15.2		14
16		14	13.9	13.8	13.7	13.7	13.5	13.3	13.1		16
18		12	11.9	11.8	11.7	11.6	11.5	11.3	11		18
20		10.4	10.4	10.2	10.1	10.1	9.9	9.8	9.6		20
22		9.2	9.1	9	8.9	8.8	8.7	8.6	8.4		22
24		8.2	8.1	8	7.9	7.8	7.6	7.5	7.3		24
26		7.3	7.3	7.1	7	6.9	6.8	6.7	6.5		26
28		6.6	6.5	6.4	6.3	6.2	6.1	6	5.8		28
30		6	5.9	5.8	5.7	5.6	5.5	5.4	5.2		30
32		5.5	5.4	5.2	5.2	5.1	4.9	4.8	4.7		32
34			4.9	4.8	4.7	4.6	4.5	4.4	4.2		34
36				4.4	4.3	4.2	4	3.9	3.7		36
38					3.9	3.8	3.7	3.6	3.4		38
40					3.6	3.5	3.3	3.2	3		40
42						3.2	3	2.9	2.7		42
44							2.8	2.7	2.4		44
46								2.5	2.2		46
48								2.2	2		48
50									1.6		50

Note: Gray shaded values are determined by strength, and others by stability.

## Boom Combination in FJ

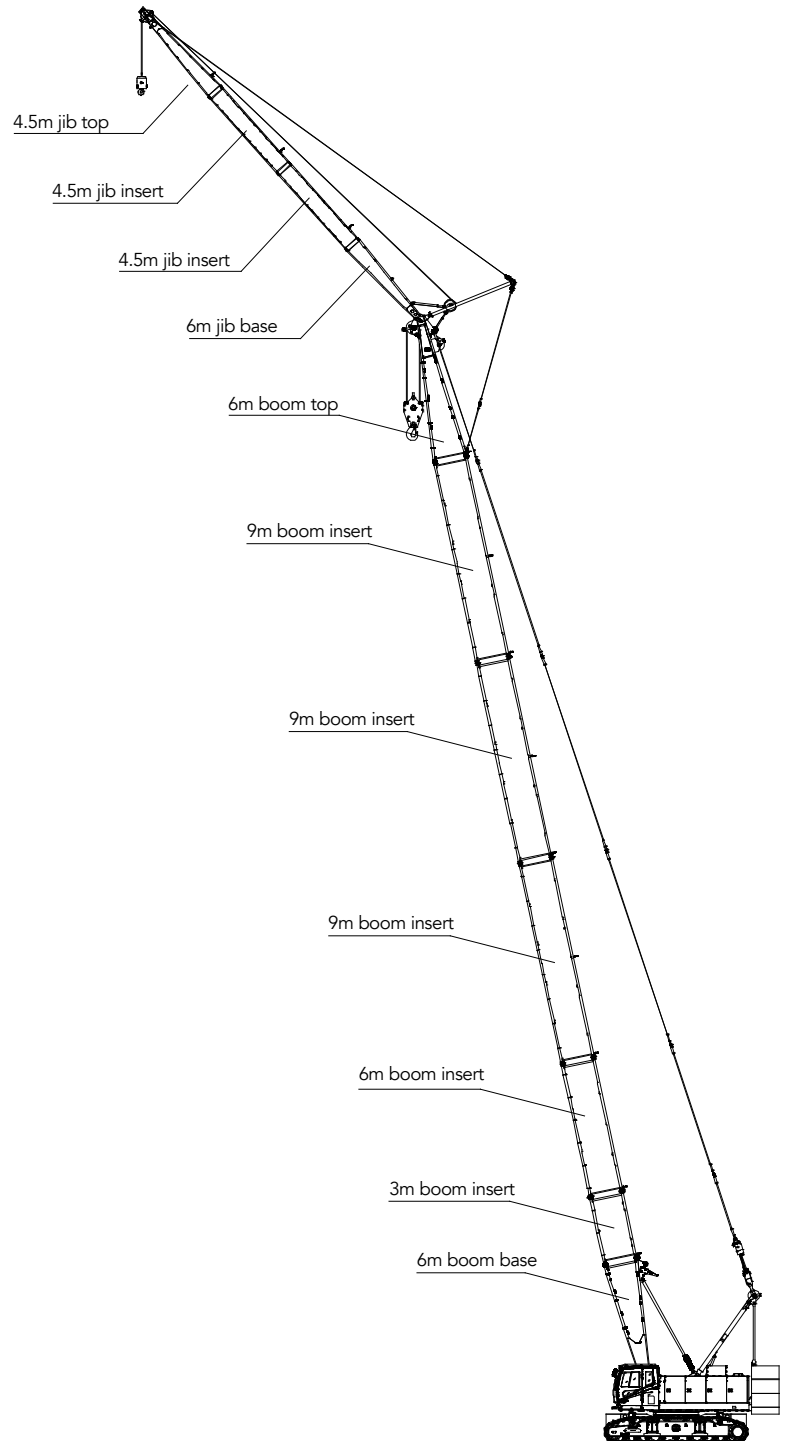
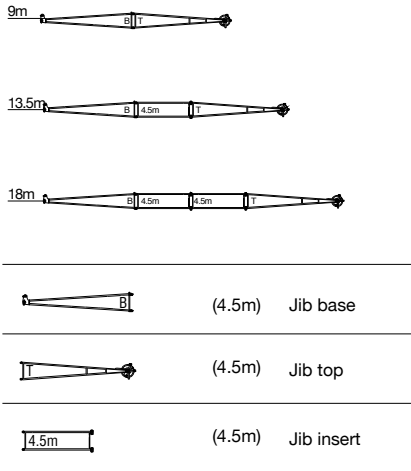

## Working Radius in FJ Configuration

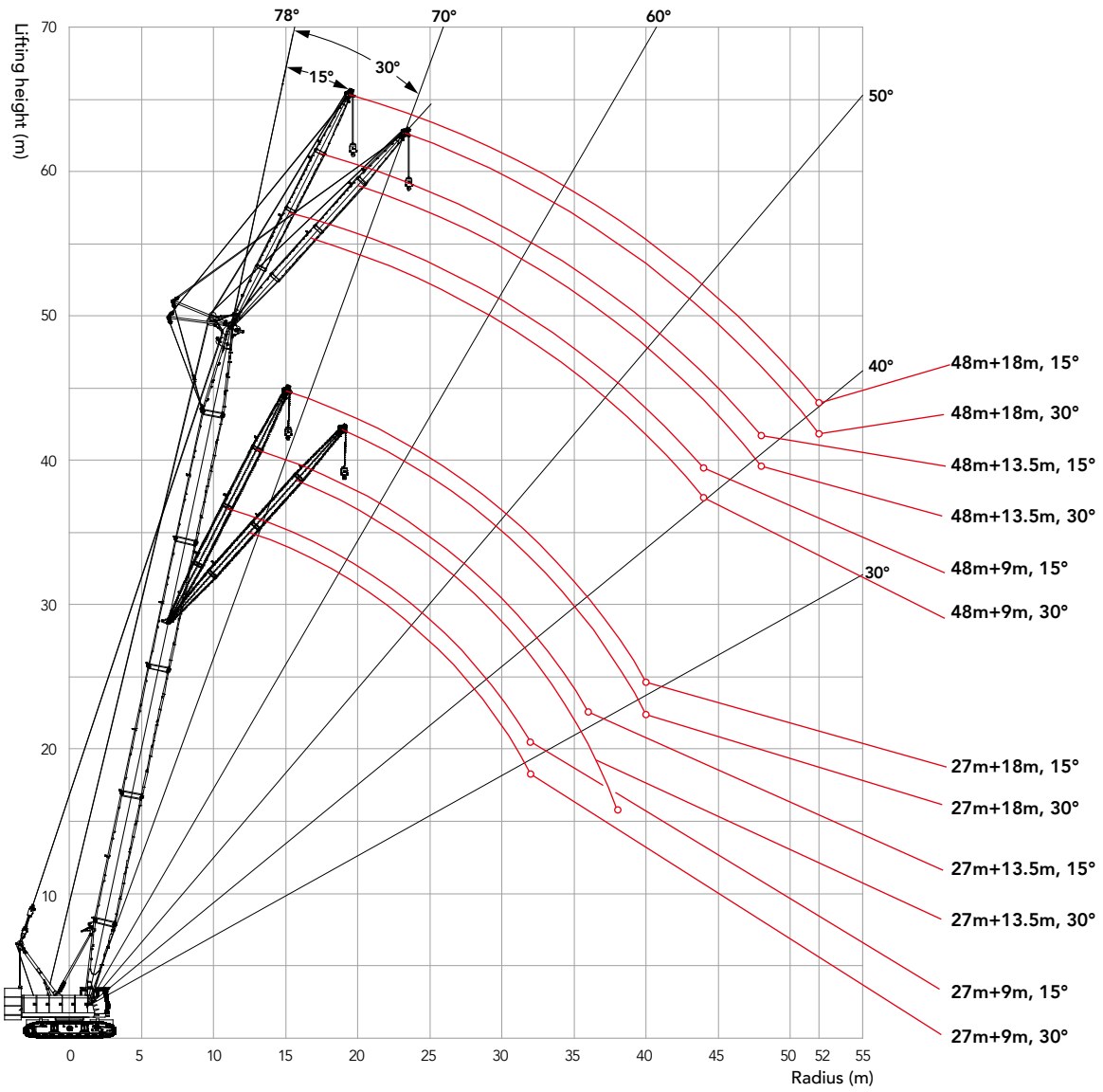



Unit: t

## Load Chart of FJ Configuration

※ Notes: Rated capacity of crawler crane:

- ① . The rated capacity in the load charts is calculated when the crane is parking on firm and level ground and lifting the load slowly and steadily.
- ② . The rated capacity values in the load charts are only valid when wind speed is lower than 9.8 m/s.
- ③ . The rated capacity in the load charts includes the weight of lifting hook, etc.; therefore, the actual rated capacity is the value after deducting the weight of lifting tools (such as lifting hook), from the rated load in the load charts.
- ④ . The crawlers must be extended during lifting.
- ⑤ . The values in the load charts are valid for 360° slewing.

SCI850A Crawler Crane–FJ Configuration 1/4														
Rear counterweight 27.6t, Carbody 7.8t														
BL (m)	27						30						BL (m)	
Jib Length (m)	9		13.5		18		9		13.5		18		Jib Length (m)	
Boom to jib angle R(m)	15°	30°	15°	30°	15°	30°	15°	30°	15°	30°	15°	30°	Boom to jib angle R(m)	
12	8						8						12	
14	8	8	8				8	8	8				14	
16	8	8	8	7	7.8		8	8	8		8		16	
18	8	8	8	6.6	7.1		8	8	8	6.7	7.3		18	
20	8	8	7.9	6.2	6.5	4.8	8	8	8	6.4	6.8	4.9	20	
22	8	8	7.3	5.9	6	4.5	8	8	7.7	6	6.3	4.6	22	
24	7.4	7.5	6.9	5.6	5.6	4.3	7.3	7.4	7.2	5.8	5.9	4.4	24	
26	6.6	6.7	6.4	5.4	5.3	4.1	6.5	6.6	6.6	5.5	5.5	4.2	26	
28	6	6	6.1	5.2	4.9	3.9	5.8	5.9	5.9	5.3	5.2	4	28	
30	5.4	5.4	5.5	5	4.7	3.7	5.2	5.3	5.4	5.1	4.9	3.8	30	
32	4.9	4.9	5	4.8	4.4	3.6	4.7	4.8	4.9	5	4.6	3.7	32	
34			4.6	4.6	4.2	3.4	4.3	4.3	4.4	4.5	4.4	3.6	34	
36			4.2	4.2	4	3.3		3.9	4	4.1	4.1	3.4	36	
38				3.8	3.9	3.2			3.7	3.7	3.8	3.3	38	
40					3.5	3.1			3.3	3.4	3.5	3.2	40	
44											2.8	2.9	44	

Note: Gray shaded values are determined by strength, and others by stability.

## Load Chart of FJ Configuration

SCI850A Crawler Crane-FJ Configuration 2/4														
Rear counterweight 27.6t, Carbody 7.8t														
BL (m)	33						36						BL (m)	
Jib Length (m)	9		13.5		18		9		13.5		18		Jib Length (m)	
R(m) \ Boom to jib angle	15°	30°	15°	30°	15°	30°	15°	30°	15°	30°	15°	30°	R(m) \ Boom to jib angle	
14	8	8	8				8						14	
16	8	8	8		8		8	8	8				16	
18	8	8	8	6.8	7.5		8	8	8	6.9	7.8		18	
20	8	8	8	6.5	7	5	8	8	8	6.6	7.2		20	
22	8	8	8	6.2	6.5	4.7	8	8	8	6.3	6.7	4.8	22	
24	7.2	7.3	7.3	5.9	6	4.5	7.1	7.2	7.2	6	6.3	4.5	24	
26	6.4	6.5	6.5	5.7	5.7	4.3	6.3	6.4	6.4	5.8	5.9	4.3	26	
28	5.7	5.8	5.8	5.5	5.4	4.1	5.6	5.7	5.7	5.6	5.5	4.2	28	
30	5.1	5.2	5.3	5.3	5.1	3.9	5	5.1	5.2	5.3	5.1	4	30	
32	4.6	4.7	4.8	4.9	4.8	3.8	4.5	4.6	4.7	4.8	4.7	3.9	32	
34	4.2	4.3	4.3	4.4	4.4	3.6	4.1	4.2	4.2	4.3	4.3	3.7	34	
36	3.8	3.8	3.9	4	4	3.5	3.7	3.8	3.8	3.9	3.9	3.6	36	
38	3.5	3.5	3.6	3.6	3.7	3.4	3.4	3.4	3.5	3.6	3.6	3.5	38	
40			3.2	3.3	3.4	3.3	3	3	3.1	3.2	3.3	3.4	40	
44					2.8	2.9			2.6	2.6	2.7	2.8	44	
48											2.2	2.3	48	

Note: Gray shaded values are determined by strength, and others by stability.

Unit: t

## Load Chart of FJ Configuration

SCI850A Crawler Crane–FJ Configuration 3/4													
Rear counterweight 27.6t, Carbody 7.8t													
BL (m)	39						42						BL (m)
Jib Length (m)	9		13.5		18		9		13.5		18		Jib Length (m)
Boom to jib angle	15°	30°	15°	30°	15°	30°	15°	30°	15°	30°	15°	30°	Boom to jib angle
R(m)													R(m)
14	8						8						14
16	8	8	8				8	8	8				16
18	8	8	8		8		8	8	8		8		18
20	8	8	8	6.7	7.4		8	8	8	6.8	7.6		20
22	7.9	8	8	6.4	6.9	4.9	7.8	8	7.8	6.5	7	5	22
24	6.9	7.1	7.1	6.1	6.4	4.7	6.8	7	7	6.3	6.3	4.7	24
26	6.1	6.3	6.3	5.9	5.9	4.5	6	6.2	6.2	6	5.7	4.5	26
28	5.5	5.6	5.6	5.7	5.4	4.3	5.4	5.5	5.5	5.7	5.3	4.3	28
30	4.9	5	5	5.2	5	4.1	4.8	4.9	4.9	5.1	4.9	4.2	30
32	4.4	4.5	4.5	4.7	4.6	4	4.3	4.4	4.4	4.6	4.5	4	32
34	4	4	4.1	4.2	4.2	3.8	3.8	3.9	4	4.1	4.1	3.9	34
36	3.6	3.6	3.7	3.8	3.8	3.7	3.4	3.5	3.6	3.7	3.7	3.8	36
38	3.2	3.2	3.3	3.4	3.4	3.6	3.1	3.1	3.2	3.3	3.3	3.5	38
40	2.8	2.9	3	3.1	3.1	3.3	2.7	2.8	2.9	3	3	3.2	40
44			2.4	2.5	2.5	2.7	2.1	2.2	2.3	2.4	2.4	2.6	44
48			1.9	1.9	2	2.1			1.8	1.8	1.9	2	48
52					1.6	1.7					1.5	1.6	52

Note: Gray shaded values are determined by strength, and others by stability.

## Load Chart of FJ Configuration

SCI850A Crawler Crane-FJ Configuration 4/4														
Rear counterweight 27.6t, Carbody 7.8t														
BL (m)	45						48						BL (m)	
Jib Length (m)	9		13.5		18		9		13.5		18		Jib Length (m)	
R(m) \ Boom to jib angle	15°	30°	15°	30°	15°	30°	15°	30°	15°	30°	15°	30°	Boom to jib angle \ R(m)	
16	8						8						16	
18	8	8	8				8	8	8				18	
20	8	8	8	7	7.5		8	8	8	7	7.3		20	
22	7.6	7.9	7.7	6.6	6.9		7.6	7.8	7.6	6.7	6.7		22	
24	6.7	6.9	6.9	6.4	6.2	4.8	6.6	6.8	6.8	6.5	6.1	4.8	24	
26	5.9	6.1	6.1	6.2	5.6	4.6	5.8	6	6	6	5.5	4.7	26	
28	5.2	5.4	5.4	5.6	5.2	4.4	5.2	5.3	5.3	5.5	5.1	4.5	28	
30	4.7	4.8	4.8	5	4.8	4.3	4.6	4.8	4.7	5	4.7	4.3	30	
32	4.2	4.3	4.3	4.5	4.4	4.1	4.1	4.2	4.2	4.4	4.3	4.1	32	
34	3.7	3.8	3.9	4	4	3.9	3.6	3.8	3.8	4	3.9	3.8	34	
36	3.3	3.4	3.4	3.6	3.6	3.6	3.2	3.3	3.4	3.6	3.5	3.6	36	
38	2.9	3	3.1	3.2	3.2	3.4	2.9	3	3	3.2	3.1	3.3	38	
40	2.6	2.7	2.7	2.9	2.9	3.1	2.5	2.6	2.7	2.8	2.8	3	40	
44	2	2.1	2.2	2.3	2.3	2.5	1.9	2	2.1	2.2	2.2	2.4	44	
48	1.5	1.6	1.7	1.7	1.8	1.9	1.5	1.5	1.6	1.7	1.7	1.9	48	
52			1.3	1.3	1.4	1.5			1.2	1.2	1.3	1.4	52	

Note: Gray shaded values are determined by strength, and others by stability.





## Zhejiang Sany Equipment Co.,LTD

SANY Crawler Crane Industrial Park, No. 2188 Daishan Road, Wuxing District, Huzhou City,  
Zhejiang Province, P. R. China Zip 313028  
Consulting [sanycrane@sanygroup.com](mailto:sanycrane@sanygroup.com) (Crane BU) / [crd@sany.com.cn](mailto:crd@sany.com.cn) (IHQ)  
After-sales Service 0086-400 6098 318

**Reminder:**

Any change in the technical parameters and configuration due to product modification or upgrade may occur without prior notice.  
The machine in the picture may include additional equipment. This brochure is for reference only, and goods in kind shall prevail.  
Copyright at SANY. No part of this brochure may be copied or used for any purpose without written approval from SANY.

© Edited in January 2023

